



United Pacific

# TRUCK

*2018 New Product Collection*





# United Pacific

## HOW TO ORDER

To order from United Pacific Industries, you must be an authorized dealer, distributor or OEM. If you are not authorized to stock and sell United Pacific products, you must order through an authorized dealer. Please call 800.790.6988 for more information.

## CONTACT US

 8 am - 4:30 pm PST

 800.790.6988 / 562.421.3888

 888.986.5988

 Sales@upauto.com

 UPauto.com

 3788 E. Conant St., Long Beach, CA 90808

## QUALITY

With over 30 years of experience in the automotive aftermarket industry, United Pacific Industries understands the rigors and stresses that our products are subjected to on the road. It is our mission to provide our customers with products of superior quality and reliability. In achieving this goal, United Pacific only partners with manufacturing facilities that conforms to our quality control requirements and standards. Our manufacturing partners meet or exceed ISO-9001 requirements. In addition, United Pacific's manufacturing partners must be equipped on site to perform the following quality assurance tests and maintain a track record of consistent quality and low product failure rate.

- Aging Test
- Air Tight Test
- Dust Test
- Flux Test
- Photometric Test
- Pull Force Test
- Rain Test
- Salt Spray Test
- Shock Test
- Temperature Test
- Humidity Test
- Vibration Test

Furthermore, our internal quality control structure allows us to function as the final quality control station prior to shipping. With the assistance of 3D computer technology, United Pacific can adhere to strict quality control standards during prototype creation and the production process. Our engineers and technicians perform a battery of tests to ensure that our products meet the demands of today's drivers and our goal to be first in quality.

## INNOVATION

Known as the leader in innovation, United Pacific is dedicated to be the first to bring new and exciting products to the market. United Pacific's global expertise allows us to search the globe for new ideas and concepts. Not only do we search the globe for new products, United Pacific invest a significant amount of resources into our own research and development efforts. With the assistance of advance 3D scanning technology, our engineers and designers can acquire accurate and precise data in seconds. The 3D data allows United Pacific to verify designs, perform quality assurance tests, and reverse engineer with unprecedented speed and accuracy. Digital inspection contributes to the early detection of shape problems, provides rapid feedback on design, and eliminates unnecessary work in downstream processes. Our rapid prototyping facility permits us to have a concept-to-shelf time of less than 5 months. In addition, United Pacific's 3D printing capabilities permit our designers to have physical models of their design concepts in hours. The physical models allow our designers and marketing staff to evaluate and test the viability of different design ideas. Our rapid prototyping facility allow United Pacific to compress design cycles, improve manufacturing planning, shorten concept-to-shelf time, most importantly, generate new and innovative products.

## DESIGN

Located near some of the nation's most progressive automotive design centers, United Pacific established the UP Design Studio in 2002 to consolidate our position as the design leader in the automotive industry. UP Design Studio utilizes the latest generation of computer aided design (CAD) and studio/graphic software. The design studio is equipped with the newest computers and rapid prototyping systems. In addition, UP Design Studio is staffed by graduates from the nation's most prestigious design colleges. Unlike our competitors, United Pacific's design and manufacturing capabilities mean that we carry more new and original items than our competitors. The establishment of the design studio will enable us to generate even more new products with significant shorter concept-to-shelf time. The reduction in development cost mean that we can develop products utilizing design based development processes. Design based product development allows United Pacific to create new product concepts based on designs incorporating driver demands and needs instead of economic considerations. United Pacific's emphasis on design distinguishes and positions us ahead of our competitors.



## WARRANTY

With LED (Light Emitting Diodes) rated at 100,000 hours of operation and solid-state construction, United Pacific's LED lights are extremely reliable and durable. Purchase with confidence, United Pacific offers a complete line of LED lighting products with extended or limited lifetime warranties. Please see the warranty policy page for more details.

## INVENTORY AND SHIPPING

United Pacific carries over 20,000 items in our California distribution center. No other company in the heavy duty trucking industry can match United Pacific in the variety and range of in-stock inventories. With an order fill rate of over 98.5%, United Pacific is the largest and most reliable supplier in the industry. Our shipping department ships 96.8% of all orders within 24 hours and 98.9% within 48 hours. United Pacific's vast inventory and prompt shipping has made United Pacific the only source for our customer's chrome and lighting needs.



HARD AT WORK FOR THE ENVIRONMENT



**United Pacific**  
**132,000** sq ft

**Distribution Center**  
**Long Beach, CA**

- 100%** reduction in potable water used for landscaping
- 40%** reduction in total energy use due to high-efficiency mechanical and lighting systems
- 82%** of construction waste was diverted from landfills

## LEED ACCOMPLISHMENTS

### Sustainable Sites

- On-site bicycle storage, showers and changing areas for company employees.
- Preferred parking for low-emitting, fuel-efficient and carpool vehicles.
- Stormwater is infiltrated on-site and treated to remove contaminants to reduce environmental impact on local waterways.

### Water Efficiency

- In addition to using reclaimed water, drought-tolerant plants and a high-efficiency irrigation system were installed to reduce the use of potable water for irrigation by 100%.

### Energy and Atmosphere

- Efficient HVAC equipment and a lighting system with daylight controls reduces energy consumption by over 30%.
- Enhanced commission verifies that the building's energy and water-related systems are performing as intended by the initial design.

### Indoor Environmental Quality

- Building ventilation systems was designed to provide enhanced levels of fresh outside air to building occupants.
- Interior finishes (plants, sealants, adhesives, coatings, carpet systems and composite wood) were selected with low levels of volatile organic compounds (VOCs) to reduce indoor air contamination.



# NEW ITEMS

January 2018



10965



10966



10967

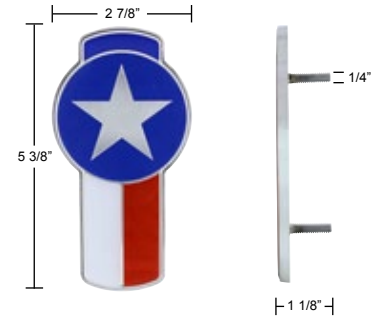

## Chrome Emblem for Kenworth T680 & T880

- Chrome Diecast Emblem for Kenworth T680 & T880
- Same size As OEM Emblem, 2 7/8" x 5 3/8"
- Mounting Studs are 3 1/8" Apart

|              |                                     |
|--------------|-------------------------------------|
| <b>10965</b> | <b>Texas Emblem</b> - 1 Pc. / Card  |
| <b>10966</b> | <b>USA Emblem</b> - 1 Pc. / Card    |
| <b>10967</b> | <b>Mexico Emblem</b> - 1 Pc. / Card |



**COMPETITION**  
SERIES



**1,020**  
LUMENS

**10v-30v**  
MULTIPLE VOLTAGE

**NEW COLOR**  
PACKAGING

## 12 High Power LED 7" Combo Light Bar

- 12 High Power LED Combo Light
- Spot/Floor: 4 Inner LEDs (Spot) / 8 Outer LEDs (Flood)
- 12 V Application, IP 67 Rated
- **3 Year Warranty**

**36599** 1 Pc. / Color Box



## High Power H4 LED Bulb with Fan

- 23W Low Beam Application, 25W High Beam Application
- 1800 Lumen Low Beam Output
- 2400 Lumen High Beam Output
- Includes Driver/Controller for Easy Installation, Replaces Any H4 Bulb. Driver/Controller is Approximately 2 3/16" L x 7/8" W x 5/8" H

**36512** 1 Pair / Color Box



31319

31320

**DOT & SAE**  
APPROVED

NEW COLOR  
PACKAGING



### Headlight Assembly for 2008+ Freightliner Cascadia

- Headlight Assembly for 2008 & Newer Freightliner Cascadia Trucks
- Easy Connection, Plug & Play Design
- Light Bulbs Included, DOT/SAE Approved
- OEM #: A06-51907-006 / A06-51907-007
- Sold Individually, Please Specify Driver or Passenger Side

**31319**      **Driver** - 1 Pc. / Color Box

**31320**      **Passenger** - 1 Pc. / Color Box

### Unique Aero Design



42824

42823

### Black Mirror Cover For 2012+ Volvo VNL

- Black Plastic Mirror Cover for 2012+ Volvo VNL
- Not OEM Design. New Aero Design Improves Efficiency and Create an Unique Look
- Sold Individually, Please Specify Driver or Passenger Side
- OEM #: 85133996/85133994

**42823**      **Driver** - 1 Pc. / Box

**42824**      **Passenger** - 1 Pc. / Box



70750

70751

### Pistol Grip 13/15/18 Speed Shift Knob

- Pistol Grip Shift Knob for 13/15/18 Speed Gearshift Knob
- Zinc Die-Cast, Available in Space Gray and Rose Gold
- Mounting Adapter Available Separately: Item # 70603B

**70750**      **Space Gray** - 1 Pc. / Card

**70751**      **Rose Gold** - 1 Pc. / Card



### United Pacific Banner

- United Pacific Banner - 48" x 36"

**99053**      1 Pc. / Bulk

### Stainless Top Mud Flap Light Bracket - Oval Light x 3

- Stainless Steel Top Mud Flap Light Bracket with Three Oval LED “GLO” Lights
- Available with Chrome Bezel with Visor (Item # 10489) and Rubber Grommet (Item # 31506)



**63816**



**63819**

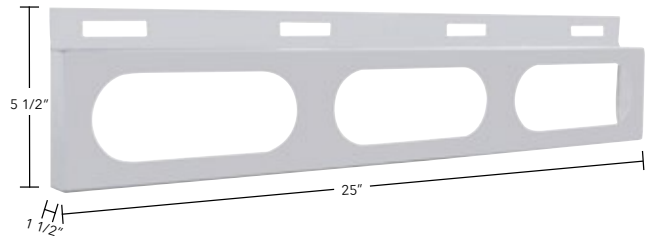

| Item #<br>with Visor | Item #<br>with Grommet | LED Lights |                   |               |              | Light Bracket |                  |
|----------------------|------------------------|------------|-------------------|---------------|--------------|---------------|------------------|
|                      |                        | Oval LED   | Item #            | LEDs          | Lens         | Item #        | Finish           |
| <b>63816</b>         | <b>63818</b>           |            | <b>37128B x 3</b> | <b>22 Red</b> | <b>Red</b>   | <b>10657</b>  | <b>Stainless</b> |
| <b>63817</b>         | <b>63819</b>           |            | <b>36924B x 3</b> | <b>22 Red</b> | <b>Clear</b> | <b>10657</b>  | <b>Stainless</b> |

### Stainless Top Mud Flap Light Bracket - 2” Light x 5

- Stainless Steel Top Mud Flap Light Bracket with Five 2” LED “GLO” Lights
- Available with Chrome Bezel with Visor (Item # 10481B) and Rubber Grommet (Item # 31505)



**63796**



**63797**

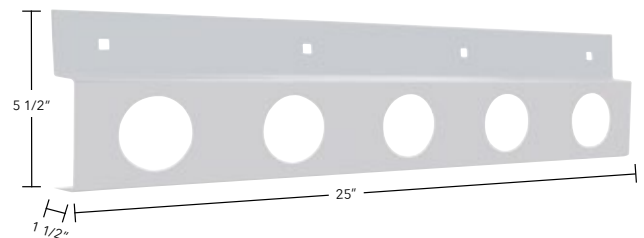

| Item #<br>with Visor | Item #<br>with Grommet | LED Lights |                   |              | Light Bracket |              |                  |
|----------------------|------------------------|------------|-------------------|--------------|---------------|--------------|------------------|
|                      |                        | 2” LED     | Item #            | LEDs         | Lens          | Item #       | Finish           |
| <b>63796</b>         | <b>63797</b>           |            | <b>37036B x 5</b> | <b>6 Red</b> | <b>Red</b>    | <b>21397</b> | <b>Stainless</b> |



## 28 LED “GLO” Light Chrome Top Mud Flap Plate

- Chrome Top Plate with 28 LED “GLO” Light Bar, Stud Mounted
- LED Light Bar with Red LED in Colored/Clear Lens
- Stainless Steel Top Plate Available Separately: Item # 10399
- Chrome Plastic Bezel Available Separately: Item # 34047B
- Sold: Bulk = 1 Piece

**GloLight™**



**63792**



**63794**

| Item #       | 17" LED Light Bar |               |              |               |
|--------------|-------------------|---------------|--------------|---------------|
|              | LED Light Bar     | LED           | Lens         | Bezel         |
| <b>63792</b> | <b>37080</b>      | <b>28 Red</b> | <b>Red</b>   | <b>-</b>      |
| <b>63793</b> | <b>37082</b>      | <b>28 Red</b> | <b>Clear</b> | <b>-</b>      |
| <b>63794</b> | <b>37080</b>      | <b>28 Red</b> | <b>Red</b>   | <b>34047B</b> |
| <b>63795</b> | <b>37082</b>      | <b>28 Red</b> | <b>Clear</b> | <b>34047B</b> |



**63793**



**63795**

## LED Chrome Top Mud Flap Plate

- Chrome Top Plate with 24 LED Light Bar, Stud Mounted
- LED Light Bar with Red LED in Colored/Clear Lens
- 24" Stainless Steel Top Plate Available Separately: Item, # 10389 / 10390
- Light Bar Housing Available Separately: Item # 30886B
- Sold: Bulk = 1 Set, Complete with Lights

**GloLight™**

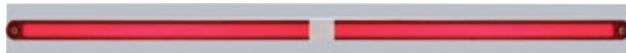

**63812**



**63814**

| Item #       | 12" LED Light Bar |               |              |                    |
|--------------|-------------------|---------------|--------------|--------------------|
|              | LED Light Bar     | LED           | Lens         | Top Mud Flap Plate |
| <b>63812</b> | <b>36862B x 2</b> | <b>24 Red</b> | <b>Red</b>   | <b>10389</b>       |
| <b>63813</b> | <b>36864B x 2</b> | <b>24 Red</b> | <b>Clear</b> | <b>10389</b>       |
| <b>63814</b> | <b>36862B x 4</b> | <b>24 Red</b> | <b>Red</b>   | <b>10390</b>       |
| <b>63815</b> | <b>36864B x 4</b> | <b>24 Red</b> | <b>Clear</b> | <b>10390</b>       |



**63813**



**63815**

## LED Chrome Top Mud Flap Plate

- Chrome Top Plate with 24 LED Light Bar, Stud Mounted
- LED Light Bar with Red LED in Colored/Clear Lens
- 24" Stainless Steel Top Plate Available Separately: Item, # 10389 / 10390
- Light Bar Housing Available Separately: Item # 30933B
- Sold: Bulk = 1 Set, Complete with Lights

**GloLight™**



**63808**



**63810**

| Item #       | 12" LED Light Bar |               |              |                    |
|--------------|-------------------|---------------|--------------|--------------------|
|              | LED Light Bar     | LED           | Lens         | Top Mud Flap Plate |
| <b>63808</b> | <b>36862B x 2</b> | <b>24 Red</b> | <b>Red</b>   | <b>10389</b>       |
| <b>63809</b> | <b>36864B x 2</b> | <b>24 Red</b> | <b>Clear</b> | <b>10389</b>       |
| <b>63810</b> | <b>36862B x 4</b> | <b>24 Red</b> | <b>Red</b>   | <b>10390</b>       |
| <b>63811</b> | <b>36864B x 4</b> | <b>24 Red</b> | <b>Clear</b> | <b>10390</b>       |



**63809**



**63811**

# NEW ITEMS

February 2018

**100% LED**

**United Pacific Exclusive**

**DOT & SAE APPROVED**

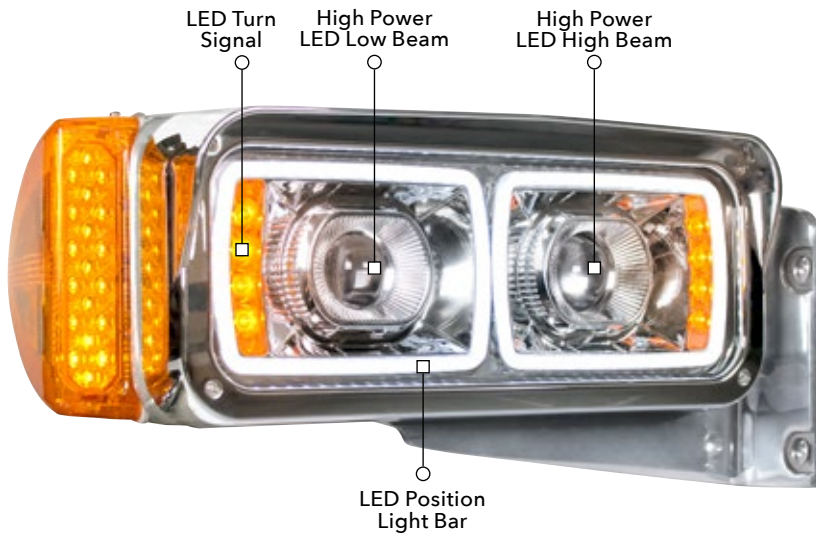

Attractive Color Packaging

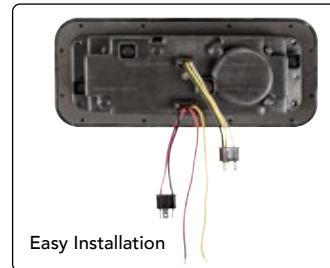

Easy Installation

## LED Projection Headlight with LED Turn Signal & 100 LED Position Light Bar For Peterbilt 357/365/378/379

- DOT/SAE Approved LED Headlight for Peterbilt 357/365/378/379
- Fits Models with Factory 4" x 6" Headlights
- Unique LED Turn Signal & Position Light Bar
- Easy Installation, Fits OEM Housing, Plugs into Existing Wiring Harness, Position Light Requires Additional Wiring
- Total Power Consumption: 70 Watts
- Available from United Pacific Only
- Sold Individually, Please Specify Driver or Passenger Side
- **1 Year Warranty**

| Technical Specification     |                              |
|-----------------------------|------------------------------|
| <b>Low Beam Application</b> | <b>High Beam Application</b> |
| 1,500 Lumens                | 2,100 Lumens                 |
| 1.5 Amps                    | 2.3 Amps                     |
| FMVSS 108                   | FMVSS 108                    |

|              |          |                                      |
|--------------|----------|--------------------------------------|
| <b>31154</b> | Chrome   | <b>Driver</b> - 1 Pc. / Color Box    |
| <b>31155</b> | Chrome   | <b>Passenger</b> - 1 Pc. / Color Box |
| <b>31156</b> | Blackout | <b>Driver</b> - 1 Pc. / Color Box    |
| <b>31157</b> | Blackout | <b>Passenger</b> - 1 Pc. / Color Box |



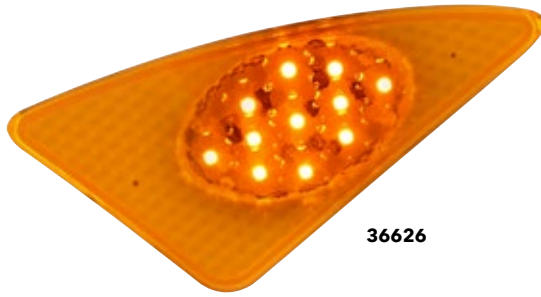

36626

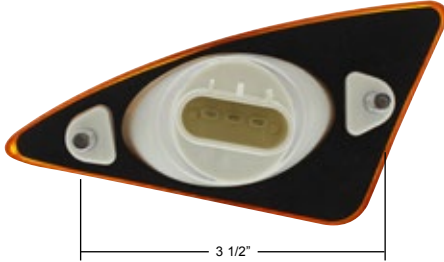

3 1/2"



### 11 Amber LED Fender Signal Light For 2008+ Kenworth T660

- 11 LED Fender Signal Light for Kenworth T170/T270/T370/T660 Trucks
- 11 Amber LED with Amber Lens
- Sold Individually, Please Specify Driver or Passenger Side
- OEM # P54-1085 / P54-1085R

**36626**     **Driver** - 1 Pc. / Card

**36627**     **Passenger** - 1 Pc. / Card



34281



34280

**GloLight™**

### Stainless Rear Center Panel

- Polished 430 Stainless Steel Center Panel w/ Enclosed Back Plate
- 21 LED 4" "GLO" S/T/T Light with Red or Clear Lens
- 9 LED 2" Marker Light with Red or Clear Lens
- Includes LED License Light, Chrome License Frame, Bullet Fastener, and Rubber Grommet

**34280**     **Red Led / Red Lens** - 1 Pc. / Box

**34281**     **Red Led / Clear Lens** - 1 Pc. / Box (**New**)



### Pinnacle Fog Light For 2008+ Mack

- Fog Light For 2008+ Mack Pinnacle Trucks
- OEM Fit, Plug into Existing Wiring Harness
- OEM #: 22067655, 48M0429M

**31189**     1 Pc. / Box



**NEW COLOR PACKAGING**

### Fog Light For Peterbilt 579/587 & Kenworth T660 Series

- Fog Light Made for Peterbilt 579/587 and Kenworth T660 Series
- OEM Fit, Plug into Existing Wiring Harness
- OEM #: P54-1062-100

**31234**     1 Pc. / Color Box



41763

41764

41765



41766

41773

41774

### Chrome Rocker Switch Cover For 2014+ Peterbilt

- Chrome Plastic Rocker Switch Cover for 2015+ Peterbilt 567 and 2014+ Peterbilt 579/587
- Double Sided Tape Mount

|              |   |
|--------------|---|
| <b>41763</b> | <b>Axle Differential</b> - 1 Pc. / Card |
| <b>41764</b> | <b>Air Suspension</b> - 1 Pc. / Card    |
| <b>41765</b> | <b>Fifth Wheel</b> - 1 Pc. / Card       |
| <b>41766</b> | <b>PTO Control</b> - 1 Pc. / Card       |
| <b>41773</b> | <b>Axle Cross</b> - 1 Pc. / Card        |
| <b>41774</b> | <b>Blank</b> - 1 Pc. / Card             |



### Chrome Rocker Switch Cover For 2014+ Peterbilt • 2 Switches

- Chrome Plastic 2 Rocker Switch Cover for 2015+ Peterbilt 567 and 2014+ Peterbilt 579/587
- Includes 5 Stainless Plaques
- Double Sided Tape Mount

**41767** 1 Pc. / Card



### Chrome Rocker Switch Cover For 2014+ Peterbilt • 3 Switches

- Chrome Plastic 3 Rocker Switch Cover for 2015+ Peterbilt 567 and 2014+ Peterbilt 579/587
- Includes 5 Stainless Plaques
- Double Sided Tape Mount

**41768** 1 Pc. / Card



### Chrome Rocker Switch Cover For 2014+ Peterbilt • 4 Switches

- Chrome Plastic 4 Rocker Switch Cover for 2015+ Peterbilt 567 and 2014+ Peterbilt 579/587
- Includes 5 Stainless Plaques
- Double Sided Tape Mount

**41769** 1 Pc. / Card



21924 21925 21926 21927 21928 21929 21930 21938 21792

### 6" Shifter Shaft Extender

- Thread On (1/2" - 13 UNC Thread), Thread 1" Long
- 3/4" Diameter Thickness

|              |   |
|--------------|---|
| <b>21924</b> | <b>Indigo Blue</b> - 1 Pc. / Card (New)           |
| <b>21925</b> | <b>Emerald Green</b> - 1 Pc. / Card (New)         |
| <b>21926</b> | <b>Cadmium Orange</b> - 1 Pc. / Card (New)        |
| <b>21927</b> | <b>Candy Red</b> - 1 Pc. / Card (New)             |
| <b>21928</b> | <b>Liquid Silver</b> - 1 Pc. / Card (New)         |
| <b>21929</b> | <b>Pearl White</b> - 1 Pc. / Card (New)           |
| <b>21930</b> | <b>Electric Yellow</b> - 1 Pc. / Card (New)       |
| <b>21938</b> | <b>Skull Pattern Wrapped</b> - 1 Pc. / Card (New) |
| <b>21792</b> | <b>Chrome</b> - 1 Pc. / Card                      |



21910 21911 21912 21913 21915 21916 21793 21796 21798

### 12" Shifter Shaft Extension

- Thread On (1/2" - 13 UNC Thread), Thread 1" Long
- 3/4" Diameter Thickness

|              |   |
|--------------|---|
| <b>21910</b> | <b>Cadmium Orange</b> - 1 Pc. / Card        |
| <b>21911</b> | <b>Indigo Blue</b> - 1 Pc. / Card           |
| <b>21912</b> | <b>Emerald Green</b> - 1 Pc. / Card         |
| <b>21913</b> | <b>Candy Red</b> - 1 Pc. / Card             |
| <b>21915</b> | <b>Pearl White</b> - 1 Pc. / Card           |
| <b>21916</b> | <b>Electric Yellow</b> - 1 Pc. / Card       |
| <b>21793</b> | <b>Chrome</b> - 1 Pc. / Card                |
| <b>21796</b> | <b>Black</b> - 1 Pc. / Card                 |
| <b>21798</b> | <b>Skull Pattern Wrapped</b> - 1 Pc. / Card |

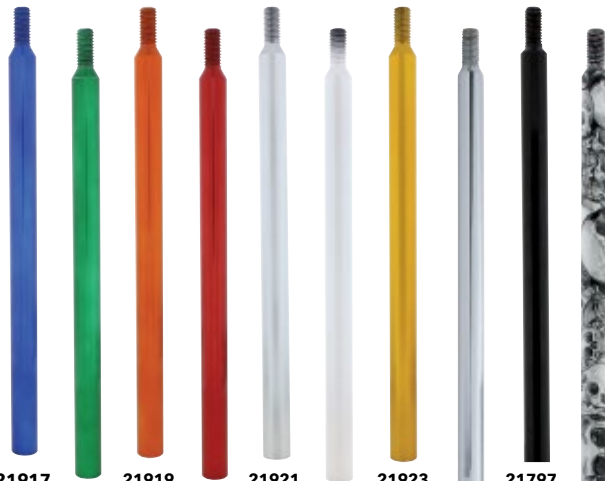

21917 21918 21919 21920 21921 21922 21923 21794 21797 21799

### 18" Shifter Shaft Extender

- Thread On (1/2" - 13 UNC Thread), Thread 1" Long
- 3/4" Diameter Thickness

|              |   |
|--------------|---|
| <b>21917</b> | <b>Indigo Blue</b> - 1 Pc. / Card (New)     |
| <b>21918</b> | <b>Emerald Green</b> - 1 Pc. / Card (New)   |
| <b>21919</b> | <b>Cadmium Orange</b> - 1 Pc. / Card (New)  |
| <b>21920</b> | <b>Candy Red</b> - 1 Pc. / Card (New)       |
| <b>21921</b> | <b>Liquid Silver</b> - 1 Pc. / Card (New)   |
| <b>21922</b> | <b>Pearl White</b> - 1 Pc. / Card (New)     |
| <b>21923</b> | <b>Electric Yellow</b> - 1 Pc. / Card (New) |
| <b>21794</b> | <b>Chrome</b> - 1 Pc. / Card                |
| <b>21797</b> | <b>Black</b> - 1 Pc. / Card                 |
| <b>21799</b> | <b>Skull Pattern Wrapped</b> - 1 Pc. / Card |



### 13/15/18 Speed Gearshift Knob

- 13/15/18 Speed Gearshift Knob for Eaton Fuller Shift Knob Assemblies
- Premium Automotive Paint in Vibrant Candy Colors, Bold Effects
- Gearshift Cover Available Separately, Item # 70176-2

|              |                                       |
|--------------|---------------------------------------|
| <b>70591</b> | <b>Cadmium Orange</b> - 1 Pc. / Card  |
| <b>70592</b> | <b>Indigo Blue</b> - 1 Pc. / Card     |
| <b>70593</b> | <b>Emerald Green</b> - 1 Pc. / Card   |
| <b>70594</b> | <b>Candy Red</b> - 1 Pc. / Card       |
| <b>70595</b> | <b>Liquid Silver</b> - 1 Pc. / Card   |
| <b>70596</b> | <b>Pearl White</b> - 1 Pc. / Card     |
| <b>70597</b> | <b>Electric Yellow</b> - 1 Pc. / Card |
| <b>70176</b> | <b>Chrome</b> - 1 Pc. / Box           |



### Chrome Grille w/ Bug Screen For 2002+ International Transtar

- Chrome Plastic Grille for 2002+ International Transtar
- Approximately 56 1/8" L x 33 1/4" W
- OEM #: 3556409C95

**21312** 1 Pc. / Box

### Unique Aero Design



**42824**

**42821**

### Mirror Cover For 2012+ Volvo VNL

- Plastic Mirror Cover for 2012+ Volvo VNL
- Not OEM Design. New Aero Design Improves Efficiency and Create a Unique Look
- Available in Chrome or Black
- Sold Individually, Please Specify Driver or Passenger Side
- OEM #: 85133995/85133998/85133996/85133994

|              |          |   |
|--------------|----------|---|
| <b>42821</b> | Chrome   | <b>Driver</b> - 1 Pc. / Box <b>(New)</b>    |
| <b>42822</b> | Chrome   | <b>Passenger</b> - 1 Pc. / Box <b>(New)</b> |
| <b>42823</b> | Blackout | <b>Driver</b> - 1 Pc. / Box                 |
| <b>42824</b> | Blackout | <b>Passenger</b> - 1 Pc. / Box              |



Energy Efficiency 360° Rotation CE & ROHS APPROVED



### Mini Cooling Turbo Fan

- Boat or Recreation Vehicles
- 360° Rotation, Universal Positioning
- Improve Vehicle Ventilation, Air Circulation, and Window De-Misting
- Easy Installation, Double Sided Tape Included
- Built-in Car Charger Head
- Comes with Fuse Inside The Plug
- 12V DC Input/0.33 Amps, Total Power Consumption: 4W
- Noise: <45db
- Power Cord Length: 10 Feet

**40847** 1 Pc. / Color Box



**99108**



**99109**

### United Pacific Truck Accessories Pop Poster

- Poster for Freightliner Cascadia & Volvo VN/VNL Parts
- Dimension Approximately = 36" W x 24" L

|              |   |
|--------------|---|
| <b>99108</b> | <b>Freightliner Cascadia</b> - 1 Pc. / Bulk |
| <b>99109</b> | <b>Volvo VN/VNL</b> - 1 Pc. / Bulk          |



### Deluxe Heavy Duty Vehicle Positioning Jack

- Ideal for Moving Vehicles in Garages, Workshops and Areas with Limited Space
- Hydraulic Ram and Pump Provides Easy Lifting Action
- Accommodates Most Automotive Tires Up to 12" Wide
- Steel Frame Construction with Steel Tire Rollers, 1500 lb. Capacity
- 6000 lb. Total Vehicle Capacity with 4 Jacks
- High Quality Polyurethane Casters for Floor Protection from Damage (2 with Toe Locks)
- Perfect for Cars, Pickup Trucks, and Light Vans
- Sold 1 Per Box, Two Jacks Are Needed Per Axle
- Optional Storage Cart Available: Item # 98998

**98999** 1 Pc. / Color Box

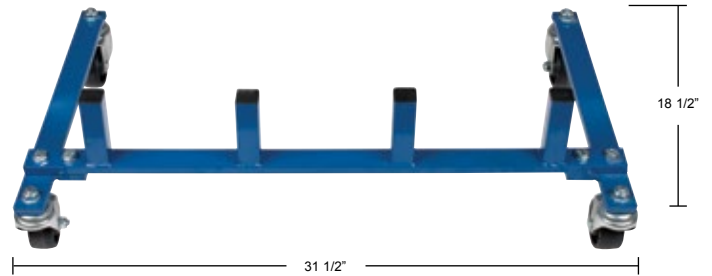

Positioning Jack:  
Item # 98999 Not Included

### Storage Cart for Vehicle Positioning Jacks

- Secure and Store up to 4 Vehicle Positioning Jacks
- Four Hard Rubber 360 Degree Swivel Ball Bearing Wheels for Easy Maneuvering
- Positioning Jack Available Separately: Item # 98999

**98998** 1 Pc. / Box

### United Pacific LED Header Sign

- United Pacific Header / Fixture Sign
- LED Header
- Perfect for Product Identification
- Dimension Approximately = 7" W x 46" L

**99036** 1 Pc. / Bulk



# NEW ITEMS

March 2018

LED HIGH &  
LOW BEAM

DOT & SAE  
APPROVED



Easy Installation, Plug & Play

## “Blackout” LED Headlight For 2008 - 2016 Freightliner Cascadia

- DOT/SAE Approved LED Headlight for 2008-2016 Freightliner Cascadia
- LED High and Low Beam Module
- Fits Various Freightliner Cascadia Models
- Sold Individually, Please Specify Driver or Passenger Side
- **1 Year Warranty**

### Technical Specification

**Low Beam Application**  
3000 Lumens  
0.22 Amps / 26 Watt  
FMVSS 108

**High Beam Application**  
1700 Lumens  
0.14 Amps / 13 Watt  
FMVSS 108



**35798**     **Driver** - 1 Pc. / Box

**35799**     **Passenger** - 1 Pc. / Box





**DOT & SAE**  
APPROVED



Easy Installation,  
Plug & Play



NEW COLOR  
PACKAGING



### Headlight Assembly for 2004+ Volvo VN

- Headlight Assembly for 2004 and Newer Volvo VN Trucks
- DOT/SAE Approved, Plug & Play Design
- Unique Aerodynamic Lens Design
- Replaces OEM Part # 82329127/82329123/82329590/82329592
- Sold Individually, Please Specify Driver or Passenger Side
- **1 Year Warranty**

### Technical Specification

**Low Beam Application**  
HB3 (9005) Bulb  
5 Amps / 60 Watt

**High Beam Application**  
H11 Bulb  
4.38 Amps / 55 Watt

**31312** Blackout

**Driver** - 1 Pc. / Color Box

**31313** Blackout

**Passenger** - 1 Pc. / Color Box

**31314** Chrome

**Driver** - 1 Pc. / Color Box

**31315** Chrome

**Passenger** - 1 Pc. / Color Box



**21052**



**21076**

### Mesh Grille with Bug Screen and Logo Mount For 2008 - 2016 Freightliner Cascadia

- Mesh Grille with Bug Screen and Logo Mount for Freightliner Cascadia
- Bug Screen Installed
- Approximately 34 1/2" L x 57 1/2" W
- Available in Chrome or Black
- OEM Number: A17-15624-002 , A17-19112-000, A17-15624-003, A17-16026-000

**21052**      **Black** - 1 Pc. / Box **(New)**

**21076**      **Chrome** - 1 Pc. / Box



**42812**



**41695**

### Hood Mirror Assembly Made for 2004 - 2014 Volvo VNL

- Mirror Assembly for 2004-2014 Volvo VNL
- Includes Complete Mirror, Mounting Arm, Backing Plate and Hardware
- Sold Individually, Please Specify Driver or Passenger Side
- Available in Chrome or Black
- OEM #: 82361058/82361059, 82299364/82334903

**42811**      Black                      **Driver** - 1 Pc. / Box **(New)**

**42812**      Black                      **Passenger** - 1 Pc. / Box **(New)**

**41695**      Chrome                      **Driver** - 1 Pc. / Box

**41696**      Chrome                      **Passenger** - 1 Pc. / Box



### 6-SMD High Power LED 6418 / 6461 36 mm Light Bulb (2 Pack)

- 36 mm 6148 / 6461 Light Bulb with 6 High Power Micro LEDs
- Specially Designed LED Bulb Projects Light 160 Degrees

|              |                              |
|--------------|------------------------------|
| <b>36591</b> | <b>Amber</b> - 2 Pcs. / Card |
| <b>36592</b> | <b>Blue</b> - 2 Pcs. / Card  |
| <b>36593</b> | <b>Red</b> - 2 Pcs. / Card   |
| <b>36594</b> | <b>White</b> - 2 Pcs. / Card |

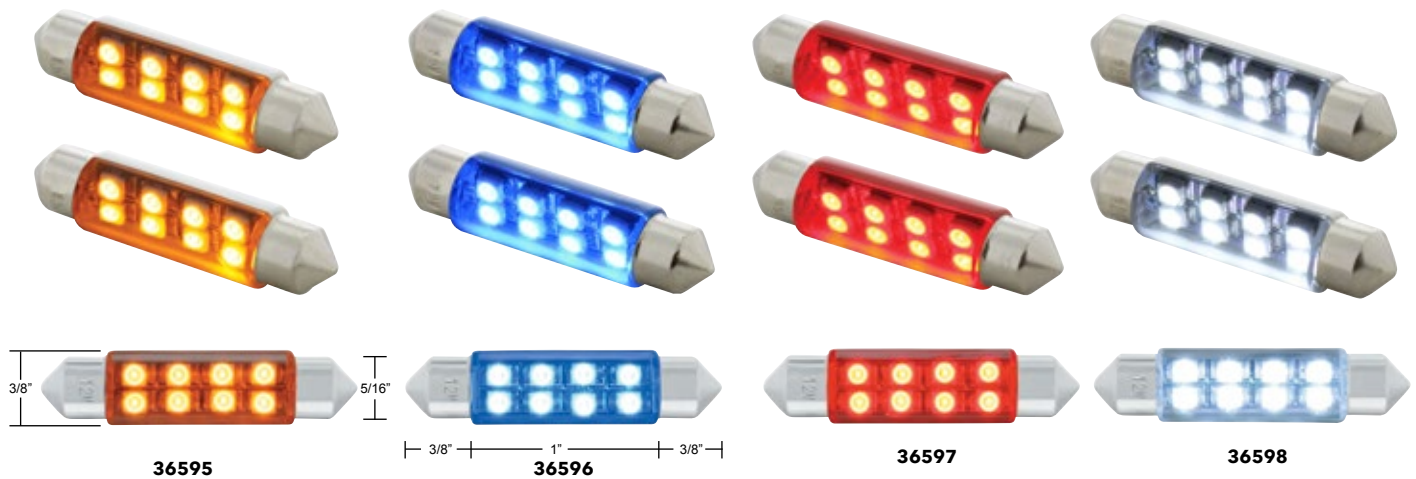

### 8-SMD High Power LED 211-2 Light Bulb (2 Pack)

- 211-2 Light Bulb with 8 High Power Micro LEDs
- Specially Designed LED Bulb Projects Light 160 Degrees

|              |                              |
|--------------|------------------------------|
| <b>36595</b> | <b>Amber</b> - 2 Pcs. / Card |
| <b>36596</b> | <b>Blue</b> - 2 Pcs. / Card  |
| <b>36597</b> | <b>Red</b> - 2 Pcs. / Card   |
| <b>36598</b> | <b>White</b> - 2 Pcs. / Card |



### Chrome Oval Confederate Flag Emblem

- Chrome Diecast Confederate Emblem
- Same Size as OEM Emblem, 8" x 3 1/4"
- Mounting Studs are 6 1/4" Apart
- Speed Nuts Included

**10946** 1 Pc. / Card



**21533**



**21534**

### Stainless Steel Permit Sticker Holder

- 430 Stainless Steel
- Fits Most Makes and Models
- Hardware Included

**21533** 6" x 30" - 1 Pc. / Bulk

**21534** 6" x 36" - 1 Pc. / Bulk

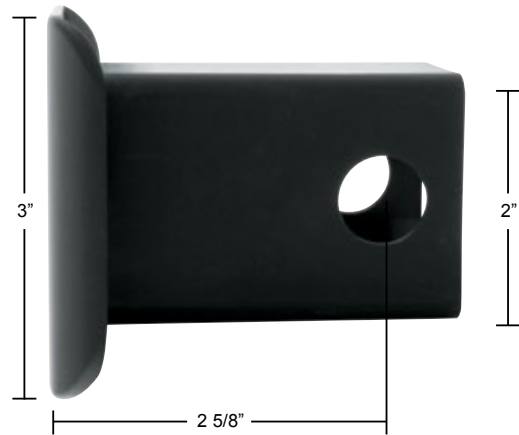

### 2" Hitch Cover

- Fits Standard 2" x 2" Tow Hitch Receivers
- Mounts in Place with Standard Locking Hitch Pin & Clip (Sold Separately)
- Keep Out Dirt and Debris, Super Clean Look

**77007** **Chrome** - 1 Pc. / Card

**77008** **Black** - 1 Pc. / Card



# NEW ITEMS

April 2018

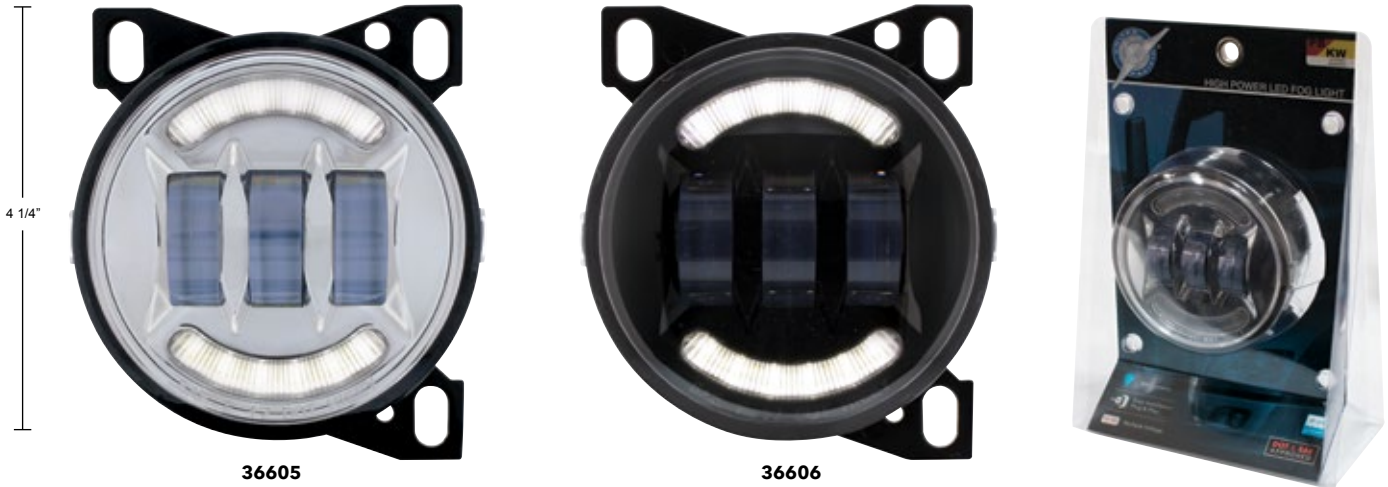

## 4 1/4" Round LED Fog Light with LED Position Light Bar for Peterbilt 579/587 & Kenworth T660 Series

- 6 High Power CREE LED Fog Light with 12 LED Position Light Bar
- Aluminum Die Cast Housing
- OEM Fit, Plug into Existing Wiring Harness
- OEM #: P54-1062-100

**DOT & SAE APPROVED**

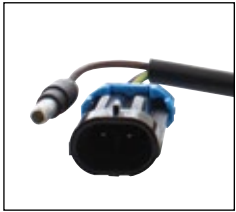

**IP-65 WATERPROOF**    **800 LUMENS**    **10v-30v MULTIPLE VOLTAGE**

|              |                              |
|--------------|------------------------------|
| <b>36605</b> | <b>Chrome</b> - 1 Pc. / Card |
| <b>36606</b> | <b>Black</b> - 1 Pc. / Card  |



**COMPETITION SERIES**    **IP-67 WATERPROOF**    **1,100 LUMENS**    **10v-30v MULTIPLE VOLTAGE**

## 6 LED Projection Auxiliary Bumper Light for 2008 - 2017 Freightliner Cascadia

- 6 High Power LED Auxiliary Light
- OEM Fit, Plug into Existing Wiring Harness
- Sold Individually, Please Specify Driver or Passenger Side
- OEM #: A06-51909-000/ A06-51909-001

|              |                                      |
|--------------|--------------------------------------|
| <b>31098</b> | <b>Driver</b> - 1 Pc. / Color Box    |
| <b>31099</b> | <b>Passenger</b> - 1 Pc. / Color Box |



**Mirage**

## Stainless Rear Center Panel - "Mirage"

- Polished 430 Stainless Steel Center Panel w/ Enclosed Back Plate
- 23 LED 4" Mirage S/T/T Light with Red or Clear Lens
- 9 LED 2" Mirage Marker Light with Red or Clear Lens
- Includes LED License Light, Chrome License Frame, Bullet Fastener, and Rubber Grommet

|              |   |
|--------------|---|
| <b>34496</b> | <b>Red LED/Red Lens</b> - 1 Pc. / Box (New)   |
| <b>34497</b> | <b>Red LED/Clear Lens</b> - 1 Pc. / Box (New) |
| <b>34498</b> | <b>Red LED/Red Lens/Visor</b> - 1 Pc. / Box   |
| <b>34499</b> | <b>Red LED/Clear Lens/Visor</b> - 1 Pc. / Box |



### 3 LED Dual Function Mini Auxiliary / Utility Light w/ Bezel

- 3 LED Mini Dual Function Clearance Marker Light with Stainless Steel Bezel
- Requires 3/4" Diameter Hole for Installation
- Fits Panels and Bumpers Up to 1/4" Thick. Includes Plastic Backing Washer When Mounting on Thin Body Panels

|              |   |
|--------------|---|
| <b>36600</b> | <b>Amber LED /Amber Lens - 1 Pc. / Card</b> |
| <b>36601</b> | <b>Red LED /Red Lens - 1 Pc. / Card</b>     |
| <b>36602</b> | <b>Amber LED /Clear Lens - 1 Pc. / Card</b> |
| <b>36603</b> | <b>Red LED /Clear Lens - 1 Pc. / Card</b>   |



### Chrome Battery Disconnect Knob for Freightliner

- Chrome Plastic Battery Disconnect Knob for Freightliner
- Fits Various Freightliner Models and Years

|              |                     |
|--------------|---------------------|
| <b>42413</b> | <b>1 Pc. / Card</b> |
|--------------|---------------------|

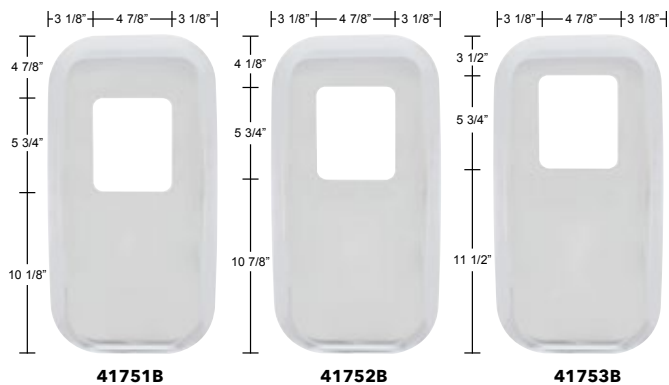

### Chrome Shift Plate Cover for Peterbilt Trucks

- Chrome Plastic Shift Plate Cover for Peterbilt 386/388/389/567/579/587
- Fits OEM Base #: S22-6041M01-234, S22-6041M01-252, S22-6041M01-268

|               |   |
|---------------|---|
| <b>41751B</b> | <b>Fits OEM S22-6041M01-234 - 1 Pc. / Box</b> |
| <b>41752B</b> | <b>Fits OEM S22-6041M01-252 - 1 Pc. / Box</b> |
| <b>41753B</b> | <b>Fits OEM S22-6041M01-268 - 1 Pc. / Box</b> |



### Chrome Smart Shift Cover for Freightliner

- Chrome Plastic Smart Shift Cover for Freightliner
- Easy Installation, Double Sided Tape Mount
- Fits Various Freightliner Models and Years

|              |                     |
|--------------|---------------------|
| <b>42415</b> | <b>1 Pc. / Card</b> |
|--------------|---------------------|



### Chrome 3 Skull Shift Knob

- Ultra High Quality Chrome Finish
- Universal Hex Screw Mount Design, Includes Mounting Hardware

**70708** 1 Pc. / Card



### Chrome 3 Skull 13/15/18 Speed Shift Knob

- Fits 13/15/18 Speed Gearshift Knobs
- Mounting Adapter Item # 70603B and 3 Skulls Shift Knob Item # 70708 Available Separately

**70752** 1 Pc. / Card

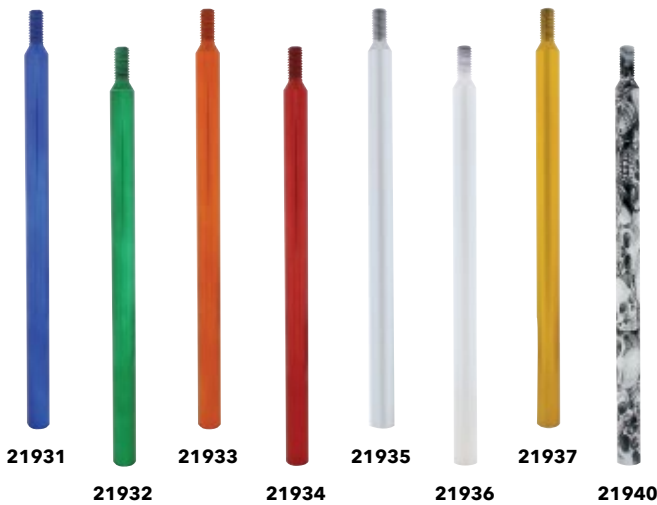

### 9" Shifter Shaft Extender

- Thread On (1/2" - 13 UNC Thread), Thread 1" Long
- 3/4" Diameter Thickness

|              |   |
|--------------|---|
| <b>21931</b> | <b>Indigo Blue - 1 Pc. / Card</b>           |
| <b>21932</b> | <b>Emerald Green - 1 Pc. / Card</b>         |
| <b>21933</b> | <b>Cadmium Orange - 1 Pc. / Card</b>        |
| <b>21934</b> | <b>Candy Red - 1 Pc. / Card</b>             |
| <b>21935</b> | <b>Liquid Silver - 1 Pc. / Card</b>         |
| <b>21936</b> | <b>Pearl White - 1 Pc. / Card</b>           |
| <b>21937</b> | <b>Electric Yellow - 1 Pc. / Card</b>       |
| <b>21940</b> | <b>Skull Pattern Wrapped - 1 Pc. / Card</b> |



### Skull Shift Knob

- Skull Shift Knob
- Zinc Die-Casted, Available in Chrome or Matte Black Finish
- Universal Hex Screw Mount Design, Includes Mounting Hardware

|              |                              |
|--------------|------------------------------|
| <b>70681</b> | <b>Chrome - 1 Pc. / Card</b> |
| <b>70699</b> | <b>Black - 1 Pc. / Card</b>  |



### 24" x 24" Stainless Quarter Fender Set - Tube Bracket

- 24" x 24" Stainless Quarter Fender with Tube Bracket
- 304 Stainless Steel, 18 Gauge
- External U Bolt Design with Back Plate for Extra Strength and Longevity
- Sold in Pairs

**11224** 1 Pair / Box



### LED Flasher w/Reverse Polarity Base & Extension Wires

- 12 Volt, 20 AMP Maximum
- Solves Turn Signal Problems, Such As Hyper Flashing, No Flashing, or Burnt Out Bulb Indication When Using LED Lights and Bulbs

**90649** 1 Set / Card

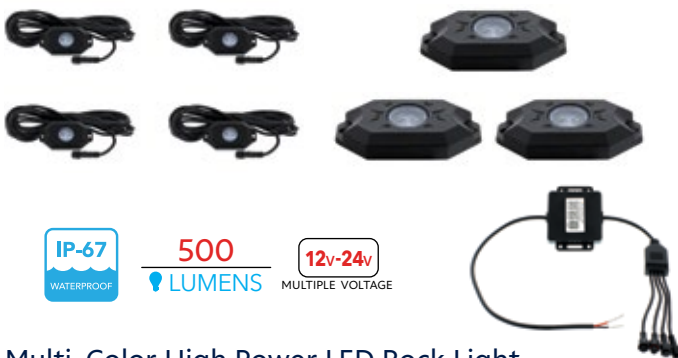
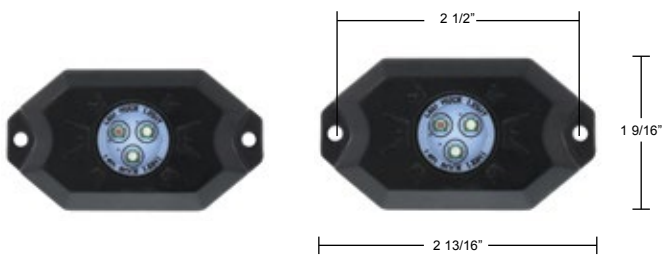

**IP-67**  
WATERPROOF

**500**  
LUMENS

**12v-24v**  
MULTIPLE VOLTAGE

### Multi-Color High Power LED Rock Light

- Multi-Color High Power LEDs for Easy Navigation When Rock Crawling
- Display Million Colors of Light with Music Beat
- Control & Dim Light with RGB Remote App. The App is Available from Apple and Android App Store
- Cree LEDs in a Waterproof and Aluminum Housing
- Mounting Pads & Spacers, Screws and Instructions Included
- Supports Most iPhone, iPad and Android Smartphone & Tablet

**36604** 1 Kit / Color Box





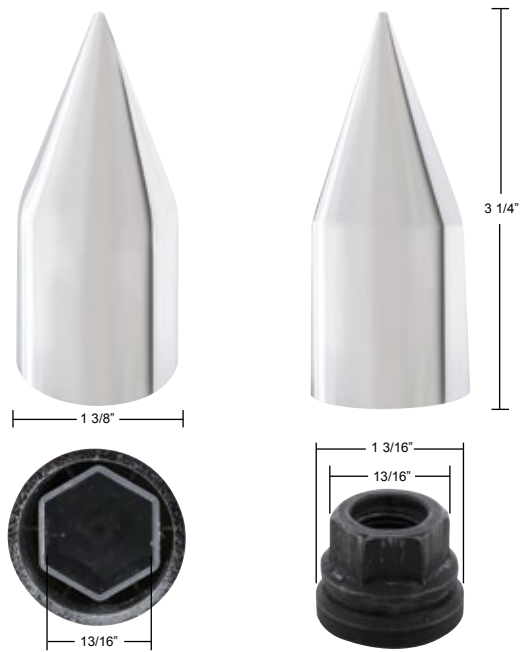

### Chrome Spike Nut Cover for 1999 - 2004 Ford F-Series - Push-On

- Fits 1999-2004 Ford F-Series Truck Models with Original Steel Wheel Hubcap
- Spike Accessory is Sized to Fit the Push-On Simulated Lug Nut on OE Steel Wheel Hubcap
- Spike is Quality Molded Plastic with Beautiful Long Lasting Chrome Plating

**10718B** 1 Pc. / BULK



### United Pacific LED Gearshift Knob Display

- United Pacific LED Gearshift Knob Display
- Includes 4 LED Gearshift Knobs

**99101** 1 Pc. / Box



Front

Back

### United Pacific Truck T-Shirt

- Black Color

**99117M** Medium - 1 Pc. / Bulk

**99117L** Large - 1 Pc. / Bulk

**99117XL** X-Large - 1 Pc. / Bulk

**99117XXL** XX-Large - 1 Pc. / Bulk

## Available Now!



Freightliner Interior Product Catalog  
- 3rd Edition, Item # UCFL3

2017 Truck New Item Product Collection Catalog  
Item # UF1217

# NEW ITEMS

May 2018

## New Design Fits A Wider Range of Trucks

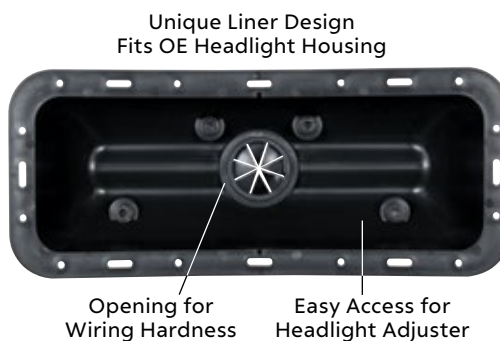
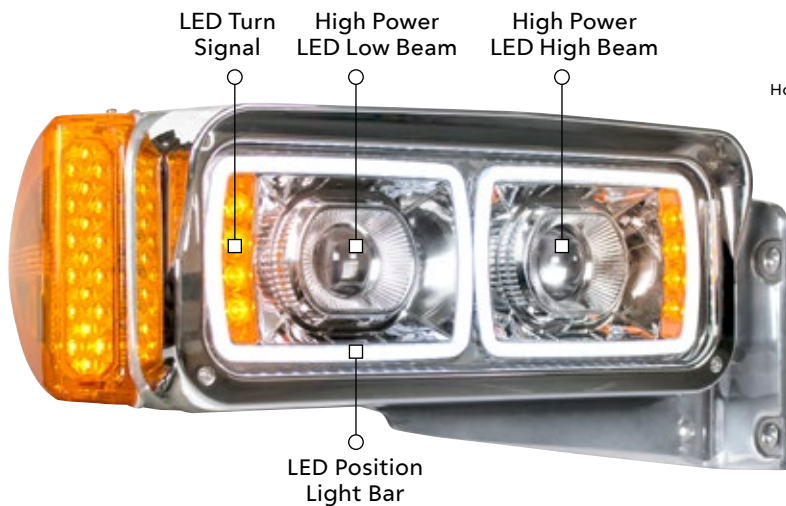

**100%LED** **United Pacific Exclusive** **DOT & SAE APPROVED**

### High Power LED Projection Headlight with LED Turn Signal & 100% LED Position Light Bar

- **Dual Function Headlight:** Low Beam & High Beam
- **Universal Design Fits:** Peterbilt 357/365/378/379 OE Headlight Housing | Fender Mounted Headlights on Kenworth T600/T800/W900 | Freightliner Classic | Western Star 4800 Series/4900 Series/6900 Series
- **All-New Durable Fender Liner** Built to Protect Rear Side Headlight from Water, Road Salt, and Debris
- **Universal Profile Design** Made for All Factory 4" x 6" Fender Mounted Headlights
- **Easy Installation,** Simply Plugs into Existing Headlight Wiring Harness  
Position Light Requires Additional Wiring
- 12VDC, Total Power Consumption: 70 Watts / 5.80 Amps
- Exclusive Design Only Available from United Pacific
- Sold Individually, Please Specify Driver or Passenger Side
- **1 Year Warranty**

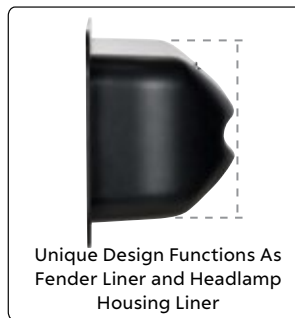

#### Technical Specification

| Low Beam Application | High Beam Application |
|----------------------|-----------------------|
| 1,500 Lumens         | 2,100 Lumens          |
| 1.5 Amps             | 2.3 Amps              |
| FMVSS 108            | FMVSS 108             |

|              |          |                                      |
|--------------|----------|--------------------------------------|
| <b>31154</b> | Chrome   | <b>Driver</b> - 1 Pc. / Color Box    |
| <b>31155</b> | Chrome   | <b>Passenger</b> - 1 Pc. / Color Box |
| <b>31156</b> | Blackout | <b>Driver</b> - 1 Pc. / Color Box    |
| <b>31157</b> | Blackout | <b>Passenger</b> - 1 Pc. / Color Box |

#### Fender Liner Also Available Separately:

|              |                                      |             |
|--------------|--------------------------------------|-------------|
| <b>31167</b> | <b>Fits Driver or Passenger Side</b> | 1 Pc. / Box |
|--------------|--------------------------------------|-------------|



### Chrome Mirror Assembly with LED Turn Signal for 2012 - 2017 Volvo VNL

- Includes Complete Mirror and Mounting Arm with Chrome Cover
- Has Power Adjustable Mirror with Heat, LED Turn Signal & Antenna
- OEM Part # 82715317/82715319
- Sold Individually, Please Specify Driver or Passenger Side

**42825** Driver - 1 Pc. / Box

**42826** Passenger - 1 Pc. / Box



### Load Resistor Kit, Solves LED Issues, 50 Watt/6 OHM

- 50W 6 Ohm LED Load Resistors for LED Turn Signal Lights or LED License Plate Lights
- Eliminate LED Turn Signal Problems, Such as Hyper Flashing, No Flashing, or Burnt Out Bulb Indication
- Simulates the Load of an Incandescent Bulb to Solve Most LED Issues
- Aluminum Housing with Proprietary Heat Management Allows Installation in Most Locations
- Kit Includes Two Load Resistors and 4 Connectors

**34235** 2 Pcs. / Color Box



**32356**

**32355**



**32589**

**32588**



**NEW COLOR PACKAGING**



**NEW COLOR PACKAGING**

### Black Fog/Driving Light Assembly for 2003 - 2017 Volvo VN/VNL

- Complete Assembly with Wire Harness
- OEM Part # 20737496/20737497
- Sold Individually, Please Specify Driver or Passenger Side

**32355** Driver - 1 Pc. / Color Box

**32356** Passenger - 1 Pc. / Color Box

### Black Fog Light Assembly for 2003 - 2017 Volvo VN/VNL

- Complete Assembly with Wire Harness, Fog Light Only
- OEM Part # 20737500/20737501
- Sold Individually, Please Specify Driver or Passenger Side

**32588** Driver - 1 Pc. / Color Box

**32589** Passenger - 1 Pc. / Color Box

# NEW ITEMS

June 2018

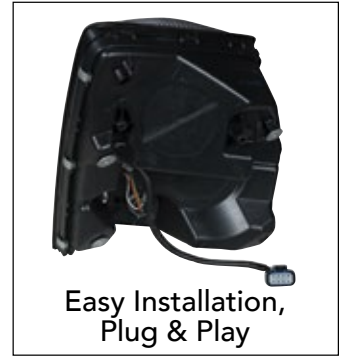

**100%LED**

**DOT & SAE  
APPROVED**

## “Blackout” LED Headlight with LED Turn Signal & LED Position Light for 2004 - 2017 Volvo VN/VNL

- LED Headlight with LED Turn Signal and LED Position Light Made For Volvo VN/VNL
- Fits 2004-2017 Volvo VN/VNL Models
- DOT/SAE and FMVSS108 Compliant
- Sold in Pairs
- **1 Year Warranty**

**35789** 1 Pair / Box



### Technical Specification

**Low Beam Application**  
12V DC Input  
3.1 Amps / 37.5 Watt  
FMVSS 108

**High Beam Application**  
12V DC Input  
3.5 Amps / 42.3 Watt  
FMVSS 108

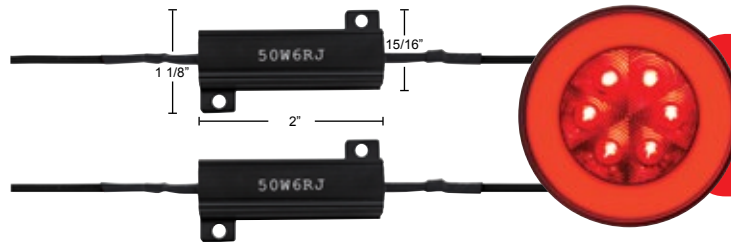

**Eliminate Hyper Flashing,  
No Flashing, or Bulb Out Signals.  
Solve Most LED Issues**

## Load Resistor Kit, Solves LED Issue, 50 Watt/6 OHM

- 50W 6Ohm LED Load Resistors for LED Turn Signal Lights or LED License Plate Lights
- Eliminate LED Turn Signal Problems, Such as Hyper Flashing, No Flashing, or Burnt Out Bulb Indication
- Simulates the Load of an Incandescent Bulb to Solve Most LED Issues
- Aluminum Housing with Proprietary Heat Management Allows Installation in Most Locations
- Kit Includes Two Load Resistors and 4 Connectors

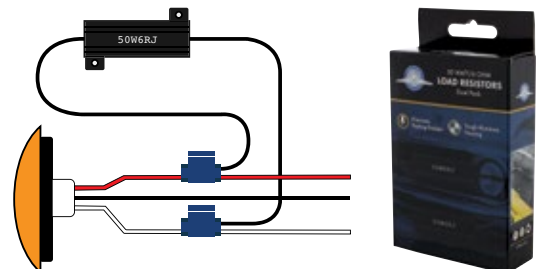

**COMPETITION  
SERIES**

**34235** 2 Pcs. / Color Box



### Stainless Dual Headlight with 8 High Power LED Bulb Made for Peterbilt 359

- 304 Stainless Steel LED Made For Light Peterbilt 359
- Light Weight and Less Maintenance than Aluminum Housing
- Give Your Truck the Classic 359 Look
- Available with 5 3/4" LED Silver Headlight: Item # 31201 or Black Headlight: Item # 31202

|              |   |
|--------------|---|
| <b>32783</b> | <b>Silver / Driver - 1 Pc. / Color Box</b>    |
| <b>32784</b> | <b>Silver / Passenger - 1 Pc. / Color Box</b> |
| <b>32785</b> | <b>Black / Driver - 1 Pc. / Color Box</b>     |
| <b>32786</b> | <b>Black / Passenger - 1 Pc. / Color Box</b>  |

## 60 60 PCS. CONVENIENCE PACK



### 33mm x 3 1/2" Thread-On Cylinder Nut Cover

- High Quality Chrome Plastic for Durability & Shine
- Fits Over Standard 33mm Lug Nuts on Hub Piloted Wheels
- Designed to Cover Up and Hide the Lug Nut Flange Washer
- Convenience Pack, Includes 60 Nut Covers to Dress Up Your Entire Truck

**10013CB** 60 Pcs. / Color Box



### 50 Caliber Bullet Shift Knob

- Ultra High Quality Finish
- Heavy Duty Solid Brass Construction Ensures Strength & Durability
- Universal Hex Screw Mount Design, Includes Mounting Hardware
- Available in T-Handle or Vertical Design

|              |                                |            |
|--------------|--------------------------------|------------|
| <b>70747</b> | <b>T-Handle - 1 Pc. / Card</b> | <b>NEW</b> |
| <b>70674</b> | <b>Vertical - 1 Pc. / Card</b> |            |



### Lower Gearshift Knob Cover

- Ultra High Quality Chrome or Automotive Candy Finish
- Dress Up Your Truck

|              |                                       |
|--------------|---------------------------------------|
| <b>70577</b> | <b>Pearl White - 1 Pc. / Card</b>     |
| <b>70578</b> | <b>Electric Yellow - 1 Pc. / Card</b> |
| <b>70579</b> | <b>Indigo Blue - 1 Pc. / Card</b>     |
| <b>70580</b> | <b>Emerald Green - 1 Pc. / Card</b>   |
| <b>70581</b> | <b>Cadmium Orange - 1 Pc. / Card</b>  |
| <b>70582</b> | <b>Candy Red - 1 Pc. / Card</b>       |
| <b>70583</b> | <b>Liquid Silver - 1 Pc. / Card</b>   |
| <b>41021</b> | <b>Chrome - 1 Pc. / Card</b>          |

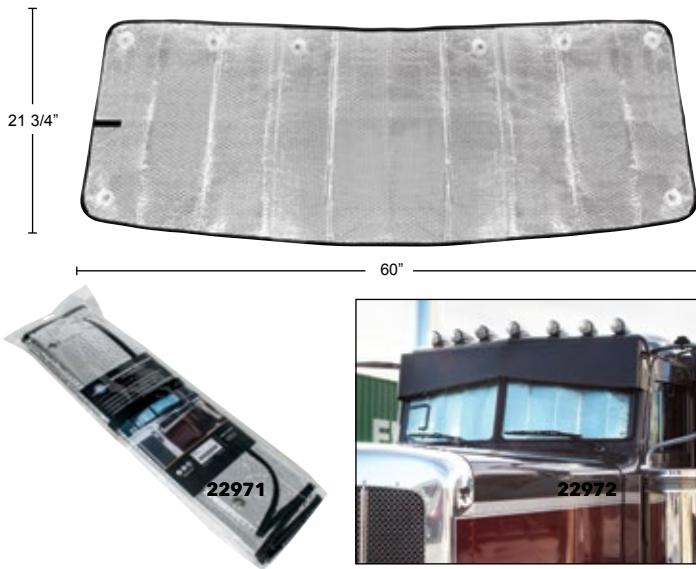

### Windshield Sunshade for Peterbilt Trucks

- Fits Peterbilt 200/300/335/337/349/353/359/375/376/377/378/379/567
- Blocks Damaging UV Rays & Keeps Interior Cool
- PE Bubble with Reflective Aluminum Coating
- Accordion Fold and Closure Strap for Quick & Easy Storage

**98994** 1 Pc. / Card



### Mini Cooling Turbo Fan

- Complete and Ready to Install in Cars, Trucks, Vans, Motor Homes, Boat or Recreation Vehicles
- 360° Rotation, Universal Positioning
- Improve Vehicle Ventilation, Air Circulation, and Window De-Misting
- Easy Installation, Double Sided Tape Included
- Built-in Car Charger Head
- Comes with Fuse Inside The Plug
- 12V DC Input/0.33 Amps, Total Power Consumption: 4W
- Noise: <45db
- Power Cord Length: 10 Feet

**40847** 1 Pc. / Color Box



### 9 High Power LED Driving/Work Light with Side LED - Spot/Flood Light

- 6 LEDs at Front - Spot Light and 3 LEDs at Side - Flood Light
- Stainless Steel Mounting Bracket and Hardware
- Operates on 12V-24V, Draws 2.8 Amps at 12V
- **3 Years Warranty**

**36509** 1 Pair / Color Box



### 2 High Power LED Work Light

- 2 High Power 5 Watt LED Work Light with Deluxe All Chrome Die-Cast Housing
- Available in Flood or Spot Pattern, **3 Year Warranty**

**36619** Flood - 1 Pc. / Card

**36620** Spot - 1 Pc. / Card

# NEW ITEMS

July 2018

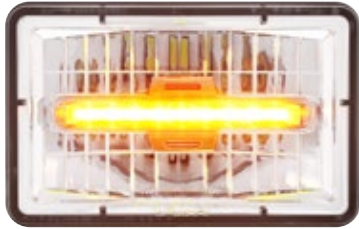

31150

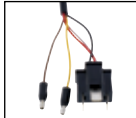

31152

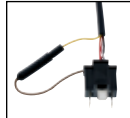

Ready to Use Position Light or Can Be Wired As DRL

## High Power LED 4" x 6" Rectangular Headlight with Position Light Bar

- Available with 9-White LED Daytime Running Light or 9-Amber LED Auxiliary Light
- Waterproof Die Cast Housing and Polycarbonate Lens Provide Maximum Protection and Durability
- OEM Fit, Plug into Existing Wiring Harness
- Sold Each, Please Specify Low Beam or High Beam



|              |  |
|--------------|--|
| <b>31150</b> | Low Beam with Amber Auxiliary Light - 1 Pc. / Color Box  |
| <b>31151</b> | High Beam with Amber Auxiliary Light - 1 Pc. / Color Box |
| <b>31152</b> | Low Beam with Daytime Running Light - 1 Pc. / Color Box  |
| <b>31153</b> | High Beam with Daytime Running Light - 1 Pc. / Color Box |



31102



31100

1/2"-13"



1,400 LUMENS

10v-30v MULTIPLE VOLTAGE

## LED Fog & Driving Light with Halo Position Light for 2008 - 2017 Freightliner Cascadia

- High Power LED Fog & Driving Light with 28 White LED Halo Position Light
- OEM Fit, Plug into Existing Wiring Harness
- LED Halo Position Light Requires Additional Wiring
- Sold Individually, Please Specify Driver or Passenger Side

**31100** Driver - 1 Pc. / Color Box

**31102** Passenger - 1 Pc. / Color Box

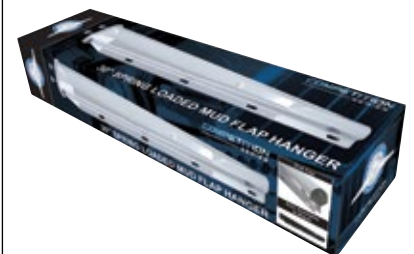

## Black 30" Spring Loaded Mud Flap Hanger - 1 1/8" Bolt Pattern

- 30" Heavy Duty Spring Loaded Mud Flap Hanger
- Black Finish
- Open End Cap
- 1 1/8" Bolt Pattern
- Stainless Steel End Plug Available Separately: Item # 20611

**11322** 1 Pair / Color Box



22956



22964



22965



23386



22971



22972



22973



### Deluxe Aluminum Screw-On Air Valve Knob

- Large Deluxe Air Valve Knob with Stainless Steel Plaque, Screw On
- Ultra High Quality Chrome or Automotive Candy Finish

#### Tractor

|       |                                |
|-------|--------------------------------|
| 22956 | Pearl White - 1 Pc. / Card     |
| 22964 | Indigo Blue - 1 Pc. / Card     |
| 22965 | Emerald Green - 1 Pc. / Card   |
| 22966 | Cadmium Orange - 1 Pc. / Card  |
| 22967 | Candy Red - 1 Pc. / Card       |
| 22968 | Electric Yellow - 1 Pc. / Card |
| 23386 | Chrome - 1 Pc. / Card          |

#### Trailer

|       |                                |
|-------|--------------------------------|
| 22957 | Pearl White - 1 Pc. / Card     |
| 22969 | Indigo Blue - 1 Pc. / Card     |
| 22970 | Emerald Green - 1 Pc. / Card   |
| 22971 | Cadmium Orange - 1 Pc. / Card  |
| 22972 | Candy Red - 1 Pc. / Card       |
| 22973 | Electric Yellow - 1 Pc. / Card |
| 23387 | Chrome - 1 Pc. / Card          |



22958



22979



22980



23364



22986



22987



22988



### Aluminum Screw-On Air Valve Knob

- Large Air Valve Knob with Stainless Steel Plaque, Screw On
- Ultra High Quality Chrome or Automotive Candy Finish

#### Tractor

|       |                                |
|-------|--------------------------------|
| 22958 | Pearl White - 1 Pc. / Card     |
| 22979 | Indigo Blue - 1 Pc. / Card     |
| 22980 | Emerald Green - 1 Pc. / Card   |
| 22981 | Cadmium Orange - 1 Pc. / Card  |
| 22982 | Candy Red - 1 Pc. / Card       |
| 22983 | Electric Yellow - 1 Pc. / Card |
| 23364 | Chrome - 1 Pc. / Card          |

#### Trailer

|       |                                |
|-------|--------------------------------|
| 22959 | Pearl White - 1 Pc. / Card     |
| 22984 | Indigo Blue - 1 Pc. / Card     |
| 22985 | Emerald Green - 1 Pc. / Card   |
| 22986 | Cadmium Orange - 1 Pc. / Card  |
| 22987 | Candy Red - 1 Pc. / Card       |
| 22988 | Electric Yellow - 1 Pc. / Card |
| 23365 | Chrome - 1 Pc. / Card          |





### Stainless Dash Blank for 2018+ Freightliner Cascadia

- Show Winning Shine, Dress Up Your Truck
- Easy Installation
- Replaces OEM #: A22-74137-001

**42435** 1 Pc. / Card

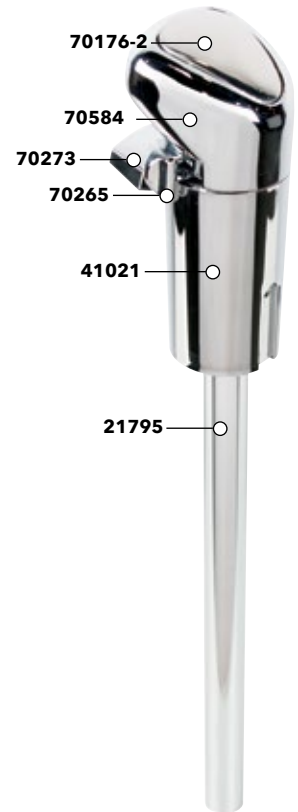

### Chrome Plastic 13/15/18 Speed Gearshift Knob

- 13/15/18 Speed Gearshift Knob for Eaton Fuller Shift Knob Assemblies
- High Quality Chrome Plastic

**70584** 1 Pc. / Card



### 1/2"-13 Thread-On Shift Knob Chrome Mounting Adapter for Eaton Fuller Style 13/15/18 Shifter

- Strong Thread-On Design with Quality Chrome Plating
- Adapts Shift Knobs with 1/2-13 Thread to Eaton Fuller Style Shifters
- Includes Inner Mounting Base with two screws

**70589B** 1 Pc. / Bulk



### 50 Caliber Bullet 13/15/18 Speed Shift Knob

- Fits 13/15/18 Speed Gearshift Knobs
- Available in T-Handle or Vertical Design
- Mounting Adapter: Item # 70603B and Bullet Knob: Item # 70747 (T-Handle) or 70674 (Vertical) Available Separately

**70753** T-Handle - 1 Pc. / Card NEW

**70590** Vertical - 1 Pc. / Card



### Bumper Receptacle for 2008 - 2012 Freightliner Cascadia

- Sold Each, Fits Driver and Passenger Side
- OEM #: 21-27302-000

**20480** 1 Pc. / Box



**90612**



**90613**



### DOT-C2 Reflective Tape

- Reflector Tape with Alternating Red and White Pattern Provided with the DOT-C2 Certification Marks as Per NHTSA 9CFR571.108
- Tape is 2" Wide, Supplied in 150 Feet Roll
- Available in 7" White/11" Red or 6" White/6" Red

**90612** 7" White/11" Red - 1 Pc. / Box

**90613** 6" White/6" Red - 1 Pc. / Box

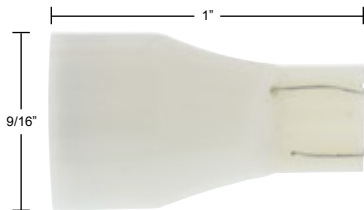

### 7 White LED 912/921 Bulb

- 912/921 Bulb with 7 Micros LEDs
- 912/921 Wedge Base, Also Fits 194 Socket

**36504** 2 Pcs. / Card

**34**  
LUMENS

### NEW "COMFORT GRIP"



**70403**



**70404**



2 1/16"



Large Grip Diameter Reduces Fatigue

### Premium 18" "Comfort Grip" Steering Wheel Cover

- Fits 18" steering wheels
- Engineered leather - long lasting look & feel of leather
- Advanced design provides extra cushion and comfort
- Large grip diameter reduces fatigue
- Available in black and brown

**70403** Black - 1 Pc. / Card

**70404** Brown - 1 Pc. / Card

# NEW COLOR PACKAGING



## Stainless Rear Center Panel - "Mirage"

- Polished 430 Stainless Steel Center Panel w/ Enclosed Back Plate
- 23 LED 4" Mirage S/T/T Light with Red or Clear Lens
- 9 LED 2" Mirage Marker Light with Red or Clear Lens
- Includes LED License Light, Chrome License Frame, Bullet Fastener, and Rubber Grommet

|              |   |
|--------------|---|
| <b>34496</b> | <b>Red LED/Red Lens</b> - 1 Pc. / Color Box         |
| <b>34497</b> | <b>Red LED/Clear Lens</b> - 1 Pc. / Color Box       |
| <b>34498</b> | <b>Red LED/Red Lens/Visor</b> - 1 Pc. / Color Box   |
| <b>34499</b> | <b>Red LED/Clear Lens/Visor</b> - 1 Pc. / Color Box |



## Stainless Rear Center Panel - "GLO"

- Polished 430 Stainless Steel Center Panel w/ Enclosed Back Plate
- 23 LED 4" GLO S/T/T Light with Red or Clear Lens
- 9 LED 2" GLO Marker Light with Red or Clear Lens
- Includes LED License Light, Chrome License Frame, Bullet Fastener, and Rubber Grommet

|              |   |
|--------------|---|
| <b>35173</b> | <b>Red LED/Red Lens</b> - 1 Pc. / Color Box         |
| <b>35174</b> | <b>Red LED/Clear Lens</b> - 1 Pc. / Color Box       |
| <b>35073</b> | <b>Red LED/Red Lens/Visor</b> - 1 Pc. / Color Box   |
| <b>35074</b> | <b>Red LED/Clear Lens/Visor</b> - 1 Pc. / Color Box |



## Stainless Rear Center Panel - "LED Reflector Light"

- Polished 430 Stainless Steel Center Panel w/ Enclosed Back Plate
- 23 LED 4" S/T/T LED Reflector Light with Red or Clear Lens
- 9 LED 2" Marker LED Reflector Light with Red or Clear Lens
- Includes LED License Light, Chrome License Frame, Bullet Fastener, and Rubber Grommet

|              |   |
|--------------|---|
| <b>34666</b> | <b>Red LED/Red Lens</b> - 1 Pc. / Color Box         |
| <b>34667</b> | <b>Red LED/Clear Lens</b> - 1 Pc. / Color Box       |
| <b>34566</b> | <b>Red LED/Red Lens/Visor</b> - 1 Pc. / Color Box   |
| <b>34567</b> | <b>Red LED/Clear Lens/Visor</b> - 1 Pc. / Color Box |



## Stainless Rear Center Panel - "LED Light"

- Polished 430 Stainless Steel Center Panel w/ Enclosed Back Plate
- 23 LED 4" S/T/T LED Light with Red or Clear Lens
- 9 LED 2" Marker LED Light with Red or Clear Lens
- Includes LED License Light, Chrome License Frame, Bullet Fastener, and Rubber Grommet

|              |   |
|--------------|---|
| <b>34664</b> | <b>Red LED/Red Lens</b> - 1 Pc. / Color Box         |
| <b>34665</b> | <b>Red LED/Clear Lens</b> - 1 Pc. / Color Box       |
| <b>34564</b> | <b>Red LED/Red Lens/Visor</b> - 1 Pc. / Color Box   |
| <b>34565</b> | <b>Red LED/Clear Lens/Visor</b> - 1 Pc. / Color Box |



### Chrome Art-Deco Nude Lady Grab Handle

- Unique Avant-Garde Design
- Quality Die Cast & Beautifully Chrome Plated
- Traditionally Used for Classic Big Rig Trucks
- Also Perfect for Doors, Cabinets, Knobs, Mancave, Garage
- Mounting hole center to center distance is 11-1/2"
- Includes Stainless Mounting Screws, Lock Nuts and Hex Wrench for Trucks
- Mounting Screws for Doors & Cabinets Not Included

**C5036-3** 1 Pc. / Box



### Headlamp Bracket for 2007-2016 Jeep Wrangler

- Sold Individually, Please Specify L/H or R/H Side
- OEM #: 55078149AC

**110585** L/H - 1 Pc. / Box

**110586** R/H - 1 Pc. / Box



### United Pacific Freightliner Truck T-Shirt

- Navy Blue Color

**99120M** Medium - 1 Pc. / Bulk

**99120L** Large - 1 Pc. / Bulk

**99120XL** X-Large - 1 Pc. / Bulk

**99120XXL** XX-Large - 1 Pc. / Bulk

# Motorcycle



### 5 3/4" Motorcycle Headlight Housing - Bottom Mount

- Available with Chrome or Black Housing

**32051** Chrome - 1 Pc. / Box

**32052** Black - 1 Pc. / Box



### 5 3/4" Motorcycle Headlight Housing - Side Mount

- Available with Chrome or Black Housing

**32053** Chrome - 1 Pc. / Box

**32054** Black - 1 Pc. / Box



### 5 3/4" Motorcycle Headlight - Bottom Mount

- Headlight Housing Available Separately: Item #32051 (Chrome) / #32052 (Black)

| Item #       | Bottom Mount Motorcycle Headlight |          |   |
|--------------|-----------------------------------|----------|---|
|              | Housing                           | Bulb     | Bulb Type   |
| <b>32787</b> | <b>32051 (Chrome)</b>             | S2005LED | Crystal Headlight w/Amber LED Auxiliary/Utility Light |
| <b>32788</b> | <b>32052 (Black)</b>              | S2005LED | Crystal Headlight w/Amber LED Auxiliary/Utility Light |
| <b>32791</b> | <b>32051 (Chrome)</b>             | 31386    | Crystal Headlight                                     |
| <b>32792</b> | <b>32052 (Black)</b>              | 31386    | Crystal Headlight                                     |
| <b>32795</b> | <b>32051 (Chrome)</b>             | 31259    | 9 LED Headlight w/Amber LED Position Light Bar        |
| <b>32796</b> | <b>32052 (Black)</b>              | 31259    | 9 LED Headlight w/Amber LED Position Light Bar        |
| <b>32799</b> | <b>32051 (Chrome)</b>             | 31267    | 9 LED Headlight w/White LED Position Light Bar        |
| <b>32800</b> | <b>32052 (Black)</b>              | 31267    | 9 LED Headlight w/White LED Position Light Bar        |
| <b>32803</b> | <b>32051 (Chrome)</b>             | 31201    | 8 High Power LED Silver Headlight                     |
| <b>32804</b> | <b>32052 (Black)</b>              | 31201    | 8 High Power LED Silver Headlight                     |
| <b>32807</b> | <b>32051 (Chrome)</b>             | 31202    | 8 High Power LED Black Headlight                      |
| <b>32808</b> | <b>32052 (Black)</b>              | 31202    | 8 High Power LED Black Headlight                      |



### Headlight Bulbs



**S2005LED**



**31386**



**31259**



**31267**



**31201**



**31202**

### 5 3/4" Motorcycle Headlight - Side Mount

- Headlight Housing Available Separately: Item #32051 (Chrome) / #32052 (Black)

| Item #       | Side Mount Motorcycle Headlight |          |   |
|--------------|---------------------------------|----------|---|
|              | Housing                         | Bulb     | Bulb Type   |
| <b>32789</b> | <b>32051 (Chrome)</b>           | S2005LED | Crystal Headlight w/Amber LED Auxiliary/Utility Light |
| <b>32790</b> | <b>32052 (Black)</b>            | S2005LED | Crystal Headlight w/Amber LED Auxiliary/Utility Light |
| <b>32793</b> | <b>32051 (Chrome)</b>           | 31386    | Crystal Headlight                                     |
| <b>32794</b> | <b>32052 (Black)</b>            | 31386    | Crystal Headlight                                     |
| <b>32797</b> | <b>32051 (Chrome)</b>           | 31259    | 9 LED Headlight w/Amber LED Position Light Bar        |
| <b>32798</b> | <b>32052 (Black)</b>            | 31259    | 9 LED Headlight w/Amber LED Position Light Bar        |
| <b>32801</b> | <b>32051 (Chrome)</b>           | 31267    | 9 LED Headlight w/White LED Position Light Bar        |
| <b>32802</b> | <b>32052 (Black)</b>            | 31267    | 9 LED Headlight w/White LED Position Light Bar        |
| <b>32805</b> | <b>32051 (Chrome)</b>           | 31201    | 8 High Power LED Silver Headlight                     |
| <b>32806</b> | <b>32052 (Black)</b>            | 31201    | 8 High Power LED Silver Headlight                     |
| <b>32809</b> | <b>32051 (Chrome)</b>           | 31202    | 8 High Power LED Black Headlight                      |
| <b>32810</b> | <b>32052 (Black)</b>            | 31202    | 8 High Power LED Black Headlight                      |



# NEW ITEMS

August 2018

Grille for Cascadia, Bumper Air Flow Deflector for Volvo VNL, Headlight Assembly for Freightliner Columbia, LED Work Lights, and more...

## Freightliner Cascadia



### Black Grille for 2018+ Freightliner Cascadia

- Fits 2018+ Freightliner Cascadia
- Approximate dims: 48 1/2" L x 29" W
- Available in black finish
- Bug screen not included
- OEM number: A17-20832-014

**21696 Black - 1 Pc. / Box**

## Volvo VNL



**21690 (Passenger)**



**21688 (Center)**



**21689 (Driver)**



### Bumper Air Flow Deflector for 2015+ Volvo VNL

- Replaces OEM numbers: 82741400(Center) / 82741404(Driver) / 82741402 (Passenger)

**21688 Center - 1 Pc. / Box**

**21689 Driver - 1 Pc. / Box**

**21690 Passenger - 1 Pc. / Box**

## LED LIGHTING



High power LED front spot light

High power LED side flood light



NEW COLOR PACKAGING



### 19 High Power LED Work Light with Side LED

- 19 high power 1.5W LEDs with spot & flood function for exceptional performance
- Flip bracket mount fits both driver's & passenger's side
- Operates on 9V-30V, draws 1.75 Amps at 12V
- 3 year warranty

**36505** 1 Pc. / Color Box

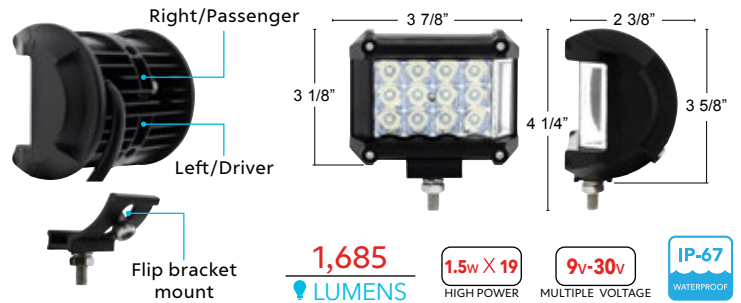

NEW COLOR PACKAGING



### High Power LED Mini Work Light

- High power 10W Cree LED with spot function
- Operates on 9V-30V, draws 0.5 Amps at 12V
- 3 year warranty

**36506** 1 Pc. / Color Box

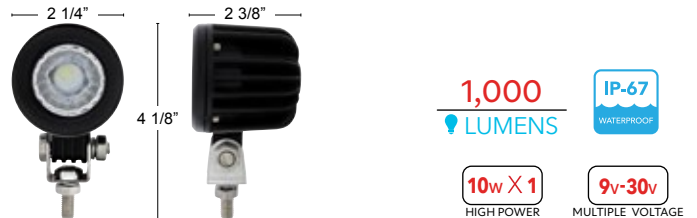

## Rear Light Bar / Panels

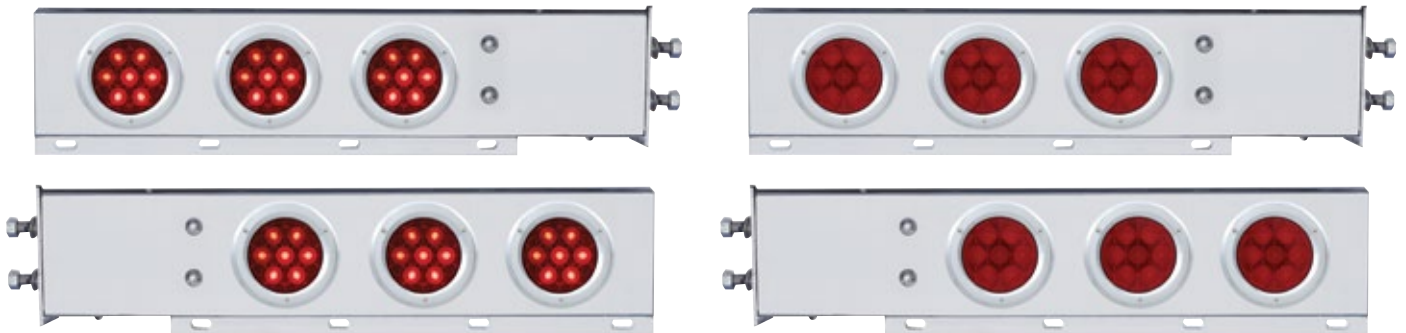

### 2 1/2" Bolt Pattern Spring Loaded Rear Light Bar w/ Six 7 LED 4" Light & Visors - Competition Series

- Spring loaded rear light bar with six 4" LED lights
- Polished 430 stainless steel three 4" light cutouts, item number 22301
- 2 1/2" bolt pattern
- 7 red LED w/ red lens S/T/T light, item number 39117B
- Chrome plastic flat Bezel, Item number 10484B

**61762** 1 Pc. / Color Box

**COMPETITION**  
SERIES

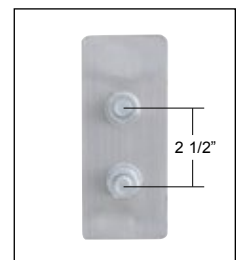



### Stainless Rear Center Panel w/ Four 7 LED 4" Light & Six 7 LED 2" Light & Visors - Competition Series

- Polished 430 stainless steel center panel w/ enclosed steel back panel, item number 21493
- 7 red LED w/ red lens S/T/T light, item number 39117B
- 9 Led 2" marker LED light, Item number 38171B
- Includes LED license light, chrome license frame, bullet fastener, and rubber grommet
- Chrome Plastic 2" Light Flat Bezel, Item number 10458B, Chrome Plastic 4" Light Flat Bezel, Item number 10484B

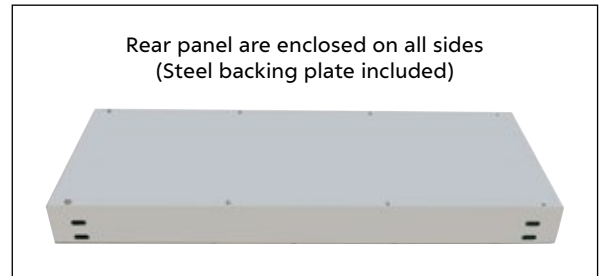

**COMPETITION**  
SERIES

**35081** 1 Pc. / Color Box

### For Peterbilt



### Chrome Rocker Switch Trim for 2010+ Peterbilt

- Chrome plastic rocker switch trim
- Fits Peterbilt 579 trucks and various 2010+ Peterbilt models
- Double sided tape mount, easy installation

**41770** Rocker Switch Trim - 1 Pc. / Card (New)

**41449** Rocker Switch Cover - 3 Pcs. / Card

**41768** Rocker Switch Cover - 1 Pcs / Card



### Chrome Center Dash Speed/Tachometer Gauge Cover for 2010+ Peterbilt

- Chrome plastic speed/tachometer gauge cover with visor
- Fits Peterbilt 579 & various 2010+ Peterbilt models
- Dress up your truck

**41756** 1 Pc. / Card



**For Kenworth**



**Chrome Menu Control Switch (MCS) Knob for Kenworth T680/T880**

- Chrome plastic Menu Control Switch (MCS) control knob
- Fits various T680/T880 Kenworth trucks
- Direct replacement for OEM control knob

**41450** 1 Pc. / Card

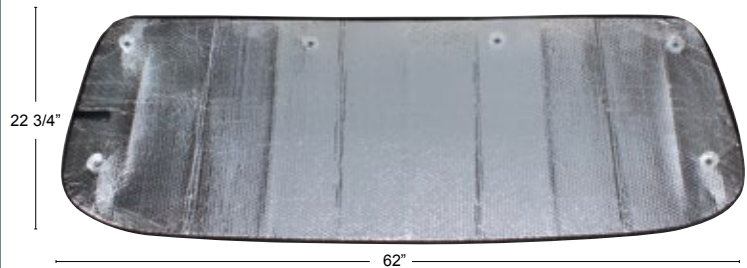

**Windshield Sunshade for 2007 - 2017 Kenworth T660**

- Blocks damaging UV rays & keeps interior cool
- PE bubble with reflective aluminum coating
- Accordion fold and closure strap for quick & easy storage

**98996** 1 Pc. / Card

**Package Upgrades / Merchandising**



**Headlight Assembly for 2004+ Freightliner Columbia**

- Easy installation, plug & play design
- Light bulb included, DOT/SAE approved
- OEM numbers: A06-75737-004/A06-75737-005
- Sold individually, please specify driver or passenger side

**31344** Driver - 1 Pc. / Color Box

**31345** Passenger - 1 Pc. / Color Box

**NEW COLOR PACKAGING**





NEW COLOR PACKAGING



**COMPETITION**  
SERIES

### Stainless 30" Spring Loaded Mud Flap Hanger with Conspicuity Reflector - 2" Bolt Pattern

- 30" Heavy duty spring loaded mud flap hanger
- 430 stainless steel with conspicuity reflector
- Open end cap / 2" bolt center
- Stainless steel end plug available separately (Item number: 20611)

**10850** 1 Pair / Color Box



### United Pacific LED Gearshift Knob Poster

- United Pacific LED gearshift knob poster

**99119** Poster - 1 Pc. / Bulk

### Universal Products



### Spike Nut Cover for Chevy & GMC Full Size Pickup

- Fits many 2003-15 Chevrolet & GMC truck models with original steel wheel hubcap
- Spike nut cover is sized to fit the twist-on simulated lug nut on OE steel wheel hubcap
- Available in chrome and black
- Spike covers sold each. **Hubcap not included**

**10349B** Black - 1 Pc. / Bulk (New)

**10351B** Chrome - 1 Pc. / Bulk

### Black 20" Steering Wheel Cover

- Fits 20" steering wheels
- Engineered leather - long lasting look & feel of leather
- Larger grip diameter reduces fatigue

**70139** 1 Pc. / Card



### Steering Wheel Spinner

- Fits 1 1/8" to 1 5/8" diameter steering wheel grips
- Classic design intended to reduce effort and fatigue
- Rubber padded clamp won't scratch wood wheel
- Not recommended for padded steering wheels

**70092** 1 Pc. / Card



Fits 20" Steering Wheel

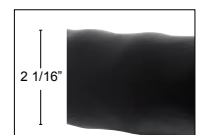

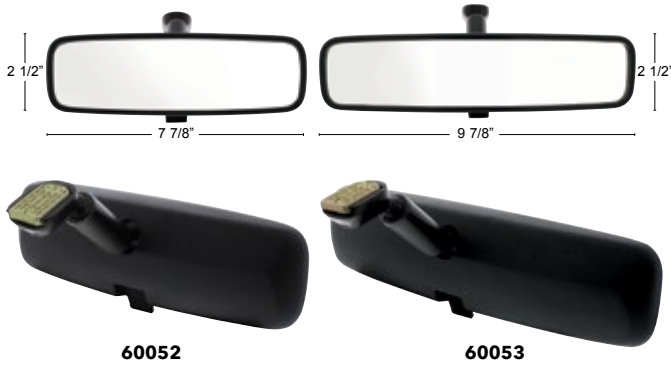

### Black Day/Night Interior Rearview Mirror Assembly - Flat Type Mount

- Convenient day/night feature
- Available in 8" & 10"

**60052** 8" - 1 Pc. / Box

**60053** 10" - 1 Pc. / Box



### Chrome Bucking Bronco Emblem

- Easy installation
- Double sided tape included for easy installation

**50130** 1 Pc. / Card



### 50" x 60" Flannel Fleece Comfort Blanket

- Ultra soft and lightweight
- Wrinkle/fade/shrink resistant
- 100% microfiber polyester
- Machine washable



**99113** Navy Blue - 1 Pc. / Card

**99114** Scarlet Red - 1 Pc. / Card

**99115** Ash Black - 1 Pc. / Card

**99116** Olive Green - 1 Pc. / Card



### Panoramic 5-Panel Rearview Mirror

- 5-panel mirror design provides wider rear view
- Easy installation in most cars, trucks & power sports vehicles
- Mounting hardware & instruction included
- May interfere with sun visors on some applications
- Recommended for performance & off-road vehicles

**60051** 1 Pc. / Color Box

### Motorcycle Parts



### Motorcycle Rubber Grip Set

- High quality molded rubber provides comfortable grip
- Old school dirt track look in 4 colors, sold in pairs
- Available for 7/8" or 1" handlebar, twist grip side has larger ID

**52000** Black 1"/1-1/8" (25/28mm) - 1 Pair / Color Box

**52001** Red 1"/1-1/8" (25/28mm) - 1 Pair / Color Box

**52002** White 1"/1-1/8" (25/28mm) - 1 Pair / Color Box

**52003** Natural 1"/1-1/8" (25/28mm) - 1 Pair / Color Box

**52004** Black 7/8"/1" (22/25mm) - 1 Pair / Color Box

**52005** Red 7/8"/1" (22/25mm) - 1 Pair / Color Box

**52006** White 7/8"/1" (22/25mm) - 1 Pair / Color Box

**52007** Natural 7/8"/1" (22/25mm) - 1 Pair / Color Box

# NEW ITEMS

September 2018

Grille for Freightliner Cascadia, Headlight Assembly for Freightliner Cascadia, Headlight Assembly for Columbia, Cascadia Cab Light, and more...

## Freightliner Cascadia



21695



21696



### Grille for 2018+ Freightliner Cascadia

- Fits 2018+ Freightliner Cascadia
- Approximate dimension: 48 1/2" L x 29" W
- Available in chrome or black finish
- Bug screen not included
- OEM number: A17-20801-006/A17-20832-014

**21695** Chrome - 1 Pc. / Box (New)

**21696** Black - 1 Pc. / Box



### "Blackout" Headlight for 2008 - 2017 Freightliner Cascadia

- LED Headlight with LED turn signal & led side marker
- Unique Dual High Power LED Low Beam Projector Module
- Fits 2008-2017 Freightliner Cascadia trucks
- DOT/SAE and FMVSS108 compliant
- Sold in pairs

**DOT & SAE**  
APPROVED



### Technical Specification

#### Low Beam Application

1,250 Lumens  
3.2 Amps / 38.4W  
FMVSS 108

#### High Beam Application

1,500 Lumens  
4.8 Amps / 57.6W  
FMVSS 108

**35788** 1 Pair / Box

**For Freightliner Cascadia**

**5 PCS. CONVENIENCE PACK**

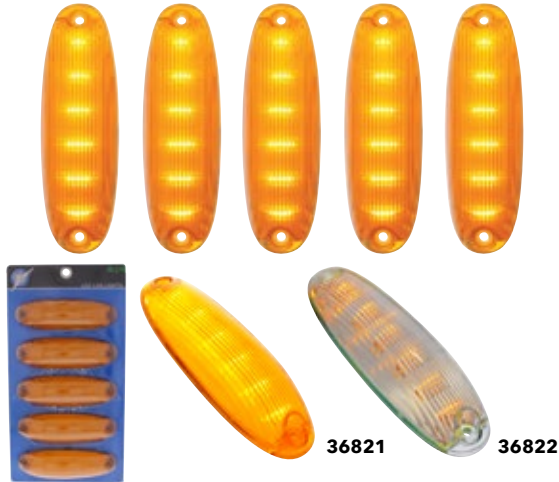

**6 LED Cab Lights for 2004+ Freightliner Cascadia**

- Convenience pack of 5, change all your cab lights at once
- Fits various 2004 and newer Freightliner Cascadia trucks
- Polycarbonate body, strong and durable
- Epoxy coated, fully sealed electronics
- Meets SAE specifications

**36821 Amber LED/Amber Lens - 5 Pcs. / Card**

**36822 Amber LED/Clear Lens - 5 Pcs. / Card**



**Exterior Door Handle for Freightliner Cascadia**

- Exterior door handle for Freightliner Cascadia
- Sold Individually, please specify driver or passenger side
- OEM number: A18-53241-001L/ A18-53241-001R

**42390 Driver - 1 Pc. / Card**

**42391 Passenger - 1 Pc. / Card**

**For Peterbilt**

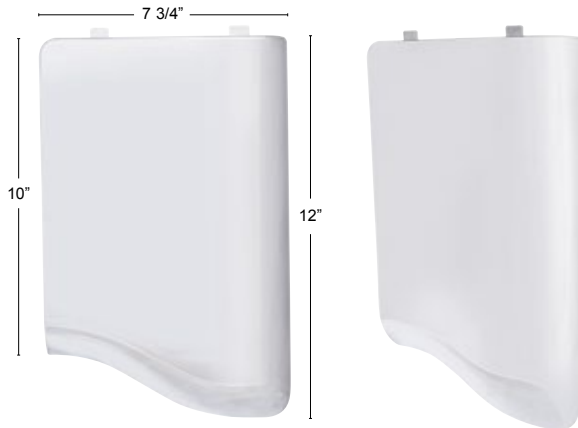

**Chrome Air Filter Door for 2010+ Peterbilt**

- Chrome plastic air filter door for 2010 and newer Peterbilt 379/386/389 trucks
- Mounting clips included
- Replaces OEM number: S25-6015-281

**41760 1 Pc. / Card**

**For Kenworth**



**Chrome Speed/Tachometer Gauge Cover for Australian Kenworth**

- Chrome Plastic Speed/Tachometer Gauge Cover
- Fits Kenworth Australian trucks
- Easy push on installation

**41443 1 Pc. / Card**

## Universal Products

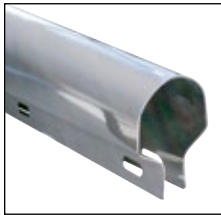

NEW COLOR PACKAGING



**COMPETITION**  
SERIES

### Chrome 30" Spring Loaded Mud Flap Hanger - 1 1/8" Bolt Pattern

- 30" Heavy duty spring loaded mud flap hanger
- Open end cap
- 1 1/8" bolt pattern

**11302** 1 Pair / Color Box

## Light Bulb



**36469**

**36470**

**36471**



### High Power 1157 LED Bulb

- Dual function LED bulb: high 275 lumens/low 150 lumens
- 360° surround illumination, 180° front illumination
- Long life sealed design

**36469** Amber - 1 Pc. / Card

**36470** Red - 1 Pc. / Card

**36471** White - 1 Pc. / Card

**COMPETITION**  
SERIES



NEW COLOR PACKAGING

### Chrome Small 4 Trumpet Air Horn

- Extra loud air horn in compact size
- Universal application, perfect for all vehicles
- Deluxe chrome finish
- Mounting hardware included
- Technical specifications:
  - Height of the 4 horns: 9 3/8" & 11 7/8"
  - Dia of the 4 horns: 3 5/8"
  - Horn Base: 5 3/8" x 6 1/8"
  - Solenoid valve voltage: 12VDC
  - Decibel Rating: 130db ± 10db

**46155** 1 Pc. / Color Box



### Xenon White 9007 Halogen Bulb

- 12V 9007 halogen bulb
- Hi/Low function
- High beam 100 watt/low beam 80 watt

**39132** 1 Pair / Clamshell

### 19 LED Flame Sequential Tail Light

- Super bright red LED with fully sealed epoxy coated electronics
- Chrome plastic flush mount flame bezel, mounting studs are approximately 5" apart
- Selector switch to control sequential function off, direction left, or direction right
- Also features a brake attention option with a sequential-once function
- 1157 double connector with offset pins, plugs into existing tail lamp socket
- Can be use as auxiliary light or motorcycle tail light.
- Requires use of United Pacific LED turn signal flasher, item number: 90652 or 90649
- Fits United Pacific chrome teardrop bezel: item number 34024B and flame bezel: item number 34025B

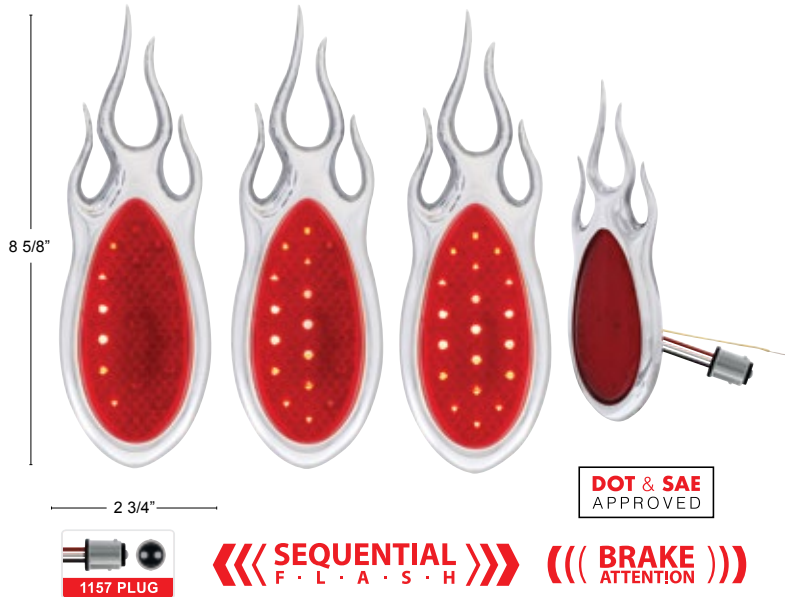

**110798** 1 Pc. / Card

### 19 LED Teardrop Sequential Tail Light

- Super bright red LED with fully sealed epoxy coated electronics
- Chrome flush mount bezel, mounting studs are approximately 5" apart
- Selector switch to control sequential function off, direction left, or direction right
- Also features a brake attention option with a sequential-once function
- 1157 double connector with offset pins, plugs into existing tail lamp socket
- Requires use of United Pacific LED turn signal flasher, item number: 90652 or 90649
- Fits United Pacific chrome teardrop bezel: item number 34024B and flame bezel: item number 34025B

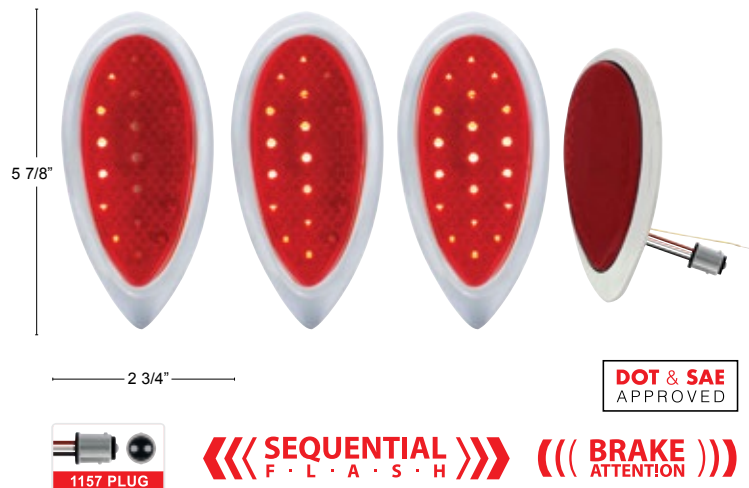

**110797** 1 Pc. / Card

### 19 LED Teardrop Sequential Tail Light

- Super bright red LED with fully sealed epoxy coated electronics
- Selector switch to control sequential function off, direction left, or direction right
- Also features a brake attention option with a sequential-once function
- 1157 double connector with offset pins, plugs into existing tail lamp socket
- Requires use of United Pacific LED turn signal flasher, item number: 90652 or 90649
- Fits United Pacific chrome teardrop bezel: item number 34024B and flame bezel: item number 34025B



**110253** 1 Pc. / Card

## Package Upgrades / Merchandising



NEW COLOR PACKAGING



### Projection Headlight Set for 1996 - 2018 Freightliner Columbia

- Headlight assembly for 1996-2018 Freightliner Columbia Trucks
- Easy connection, plug & play design, plugs into existing headlight wiring harness
- Amber turn signal light bulb (1157) included
- Headlight bulbs included, DOT/SAE headlight approved
- 1 driver/left side and 1 passenger/right side assembly included
- Replaces OEM number: A06-75737-004
- Sold in pairs, 1 year warranty



**31346** 1 Pair / Color Box

### Technical Specification

**Low Beam Application**  
12V DC Input  
9007 Light Bulb  
4.3 Amps / 55 Watt

**High Beam Application**  
12V DC Input  
9007 Light Bulb  
5.1 Amps / 65 Watt



### Display for Peterbilt Front Turn Signal

- Display for Peterbilt Front Turn Signal, item number: 38396 & 38550
- Attractive counter top display with interactive push buttons
- Ready to use, requires 110V outlet
- Creates customer demand to drive sales

**99105** 1 Pc. / Box

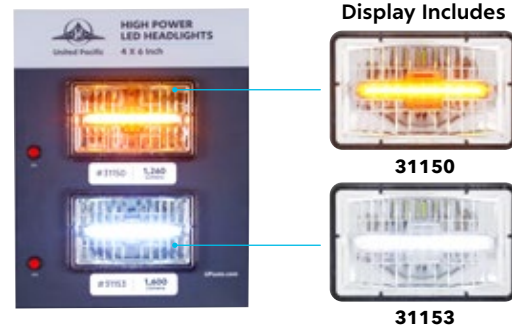

### Display for 4" x 6" DOT Headlight

- Attractive counter top display with interactive push buttons
- Ready to use, requires 110V outlet

**99124** 1 Pc. / Box



### Display for 4" x 6" Rectangular Light

- Attractive counter top display with interactive push buttons
- Ready to use, requires 110V outlet

**99125** 1 Pc. / Box



## Jeep Wrangler Parts



### Headlight Assembly for 1997-2006 Jeep Wrangler

- Excellent OEM style headlight bracket: item number 110383/110384
- Includes 7" quartz halogen sealed beam bulb - UP item number 30356
- Sold individually, please specify left or right hand side

**110799** L/H - 1 Pc. / Card

**110800** R/H - 1 Pc. / Card



### Headlight Bracket for 1997-2006 Jeep Wrangler

- Excellent OEM style headlight bracket for the 1997-2006 Jeep Wrangler
- Plastic injection molded high quality durable plastic material
- Sold individually, please specify left or right hand side

**110383** L/H - 1 Pc. / Card

**110384** R/H - 1 Pc. / Card



### Headlight Assembly for 2007-2016 Jeep Wrangler

- Excellent OEM style headlight bracket: item number 110383/110384
- Includes 7" H4 quartz halogen crystal headlight bulb - UP item number: 31387
- Sold individually, please specify left or right hand side

**110801** L/H - 1 Pc. / Card

**110802** R/H - 1 Pc. / Card



**110585**

**110586**

### Headlamp Bracket for 2007-2016 Jeep Wrangler

- Sold Individually, Please Specify L/H or R/H Side
- OEM #: 55078149AC

**110585** L/H - 1 Pc. / Box

**110586** R/H - 1 Pc. / Box

# NEW ITEMS

October 2018

Headlight Assembly for Freightliner Columbia & Volvo VN/VNL, Mirror Cover for Freightliner Cascadia, and more...

## Freightliner Columbia



### High Power LED Projection Headlight for 1996 - 2018 Freightliner Columbia

- High power LED projection headlight with 6 LED turn signal and 52 LED position light bar
- Headlight assembly for 1996-2018 Freightliner Columbia trucks
- Easy connection, plugs into existing wiring harness, position light requires additional wiring
- DOT/SAE and FMVSS compliant
- Available in chrome or black finish
- Sold individually, please specify driver or passenger side

### Technical Specification

| Low Beam Application | High Beam Application |
|----------------------|-----------------------|
| 1,300 Lumens         | 1,500 Lumens          |
| 1 Amps / 12V         | 1 Amps / 12V          |
| FMVSS 108            | FMVSS 108             |

|              |                 |                                      |
|--------------|-----------------|--------------------------------------|
| <b>31090</b> | <b>Chrome</b>   | <b>Driver - 1 Pc. / Color Box</b>    |
| <b>31091</b> | <b>Chrome</b>   | <b>Passenger - 1 Pc. / Color Box</b> |
| <b>31092</b> | <b>Blackout</b> | <b>Driver - 1 Pc. / Color Box</b>    |
| <b>31093</b> | <b>Blackout</b> | <b>Passenger - 1 Pc. / Color Box</b> |

## Volvo VN/VNL



### High Power LED Headlight for 2004 - 2017 Volvo VN/VNL

- Headlight assembly for 2004-2017 Volvo VN/VNL trucks and newer
- High-power 7W LEDs provide superior performance
- Aerodynamic lens design
- Amber turn signal light bulb (3157) included
- Easy connection, plug & play design, plugs into existing headlight wiring harness
- Replaces OEM number: 82329590/82329124/82329592/82329127
- Sold individually, please specify driver or passenger side

### Technical Specification

| Low Beam Application | High Beam Application |
|----------------------|-----------------------|
| 1,590 Lumens         | 2,240 Lumens          |
| 2.15 Amps / 12V      | 3.85 Amps / 12V       |
| FMVSS 108            | FMVSS 108             |

|              |                 |                                      |
|--------------|-----------------|--------------------------------------|
| <b>31094</b> | <b>Chrome</b>   | <b>Driver - 1 Pc. / Color Box</b>    |
| <b>31095</b> | <b>Chrome</b>   | <b>Passenger - 1 Pc. / Color Box</b> |
| <b>31096</b> | <b>Blackout</b> | <b>Driver - 1 Pc. / Color Box</b>    |
| <b>31097</b> | <b>Blackout</b> | <b>Passenger - 1 Pc. / Color Box</b> |

## LED Headlight



### Technical Specification

| Low Beam Application | High Beam Application |
|----------------------|-----------------------|
| 12V 1.2A / 24V 0.6A  | 12V 1.3A / 24V 1.0A   |
| 1,000 Lumens         | 2,000 Lumens          |

### 7" High Power LED Headlight with LED Position Light Bar

- High power led headlight with LED position light bar for powerful performance
- Dual function headlight: low beam & high beam
- Aluminum housing with proprietary heat management provides maximum protection for long-lasting performance
- Solid state design resists shock and vibration
- Easy connection, fits OEM housing or fender, plugs into existing wiring harness, position light requires additional wiring
- DOT/SAE headlight approved

**31200** 1 Pc. / Color Box

## LED Square Cab Light

### 5 5 PCS. CONVENIENCE PACK



**36399**

**36400**

Rectangular Cab  
Light Housing



**30526-1**

**100%LED**

**DOT & SAE  
APPROVED**

### 36 LED Square Cab Light

- Polycarbonate body, epoxy coated, fully sealed electronic
- Fits existing light housing
- 2 wire connection with 1 ring terminal
- 36 amber LEDs with amber lens or clear lens

**36399** 36 Amber LED/Amber Lens - 5 Pcs. / Color Box

**36400** 36 Amber LED/Clear Lens - 5 Pcs. / Color Box



### High Power 9006/HB4 LED Bulb

- 20W low beam application
- 2300 lumen output
- Forced convection design with cooling fan and heat sink, to increase service life
- Includes driver/controller for easy installation, made to fit most 9006/HB4 applications
- Driver/controller is approximately 2 1/4" L x 15/16" W x 5/8" H

**36513** 1 Pair / Color Box

### 5 5 PCS. CONVENIENCE PACK



**36401**

**36402**

Rectangular Cab  
Light Housing



**30526-1**

**100%LED**

**DOT & SAE  
APPROVED**

### 17 LED Reflector Square Cab Light

- Polycarbonate body, epoxy coated, fully sealed electronic
- Fits existing light housing
- 2 wire connection with 1 ring terminal
- 17 amber LEDs with amber lens or clear lens

**36401** 17 Amber LED/Amber Lens - 5 Pcs. / Color Box

**36402** 17 Amber LED/Clear Lens - 5 Pcs. / Color Box

**Chrome Billet Style  
14" Steering Wheel  
for Commercial Trucks**

*\*For Offroad Show Only\**



Create your own unique 14" billet style aluminum steering wheel. All you need to do is select your favorite 14" aluminum wheel style, add the horn button and a 3 bolt/9 screw adapter. Finally, you can use your existing 3 bolt steering wheel hub or purchase a new United Pacific steering wheel hub. All parts sold separately.



### 14" Chrome Billet Aluminum Steering Wheel

- 14" Chrome aluminum steering wheel with comfortable black leather grip
- Requires standard 9-screw steering wheel hub adapter and horn button kit, sold separately
- Well packaged in attractive color box

**88300** 3 Spoke Style - 1 Pc. / Color Box

**88301** Boss Style - 1 Pc. / Color Box

**88302** Blade Style - 1 Pc. / Color Box

**88303** Chopper Style - 1 Pc. / Color Box

**88304** Scorpion Style - 1 Pc. / Color Box



### Chrome Billet Style Aluminum Horn Button for 9-Screw Steering Wheel

- Highly polished aluminum billet style horn button
- Fits United Pacific 3-bolt/9 screw hub adapter: Item number 88305
- 3 1/4" inside diameter
- 4 1/4" outside diameter

**88306** 1 Pc. / Box



### Chrome Aluminum 3-Bolt Hub Adapter for 9-Screw Steering Wheel

- Adapts any United Pacific 9-screw steering wheel to commercial truck 3-bolt hubs
- Quality diecast aluminum, chrome plated - perfect custom touch for show trucks
- Standard 8-32 thread for steering wheels. (Note: 9 screws are included with steering wheels)
- Reduce steering input to shorten circular distance
- Recommended for commercial trucks with power steering only

**88305** 1 Pc. / Box



### United Pacific Steering Wheel Hubs

- Chrome diecast steering hub for United Pacific steering wheels
- Item number 88211, 88212, 88213, and 88259 sold with horn button and bezel
- Horn button and bezel not used in the installation of 14"
- Steering wheel, will need to purchase item # 88306 for 14" steering wheel installation

**88211** PB 1998-2005/KW 2001-2002 - 1 Pc. / Color Box

**88212** FL 1989-2006 - 1 Pc. / Color Box

**88213** International - 1 Pc. / Color Box

**88238** FL 2007+ - 1 Pc. / Color Box

**88259** PB 2006+/Kenworth 2003+ - 1 Pc. / Color Box

## For Freightliner Cascadia



### Aero Mirror Cover for 2008 - 2017 Freightliner Cascadia

- Chrome plastic mirror cover for 2008-2017 Freightliner Cascadia trucks
- Mount directly onto the mirror bracket/post
- Replaces OEM number: A22-69637-006/A22-69637-003
- Sold individually, please specify driver or passenger side

**42388 Driver - 1 Pc. / Color Box**

**42389 Passenger - 1 Pc. / Color Box**

## For Kenworth T680



### Chrome Fuse Compartment Access Cover for Kenworth T680

- Chrome plastic fuse compartment cover
- Fits various Kenworth T680 trucks and years
- Mounting clips included
- Replaces OEM number: S22-6100-671

**42790 1 Pc. / Card**

## Universal Products



**88174**



**88175**



**88176**



**88177**

### 18" Chrome Steering Wheel with Skull Accent

- 18" wheel rim steering wheel with chrome spoke
- 4 spoke steering wheel
- Chrome die cast skull accent, unique skull design
- Mix and match with United Pacific hub and designer horn bezel for a unique and distinctive look

**88174 Wood - 1 Pc. / Color Box**

**88175 Blue - 1 Pc. / Color Box**

**88176 Red - 1 Pc. / Color Box**

**88177 Black - 1 Pc. / Color Box**



18" STEERING WHEEL





67008



67009



67010



67011



67012



67013



10408

### Chrome 4" x 24" Bottom Mud Flap Plate - Welded Stud

- Bottom plate with oval emblems
- Welded stud mounting
- Unique chrome die cast emblem assembled
- Mounting hardware included

|              |  |
|--------------|--|
| <b>67008</b> | <b>USA - 1 Pc. / Skin Pack</b>                 |
| <b>67009</b> | <b>Texas - 1 Pc. / Skin Pack</b>               |
| <b>67010</b> | <b>Mexico - 1 Pc. / Skin Pack</b>              |
| <b>67011</b> | <b>Confederate - 1 Pc. / Skin Pack</b>         |
| <b>67012</b> | <b>Skull - 1 Pc. / Skin Pack</b>               |
| <b>67013</b> | <b>Eagle - 1 Pc. / Skin Pack</b>               |
| <b>10408</b> | <b>Plain with emblem cutout - 1 Pc. / Bulk</b> |



10924



10934



10945



10946



10963



10964

### Chrome Oval Emblem

- Chrome diecast emblem for Peterbilt
- Mounting studs are 6 1/4" apart
- Speed Nuts Included

|              |  |
|--------------|--|
| <b>10924</b> | <b>Mexico - 1 Pc. / Card</b>           |
| <b>10934</b> | <b>Texas - 1 Pc. / Skin Pack</b>       |
| <b>10945</b> | <b>USA - 1 Pc. / Skin Pack</b>         |
| <b>10946</b> | <b>Confederate - 1 Pc. / Skin Pack</b> |
| <b>10963</b> | <b>Skull - 1 Pc. / Skin Pack</b>       |
| <b>10964</b> | <b>Eagle - 1 Pc. / Skin Pack</b>       |



### 33 mm Thread-On Spike Rear Axle Cover Set

- Chrome plastic spike rear axle cover with removable cap
- Extra tall center cap for unique style look
- Universal fit, fits most 11 1/4" and bolt circle/center applications
- Spike 33 mm thread-on nut cover
- Fits 10-hole, 22 1/5" and 24 1/5" hub and stud piloted wheels
- Includes 1 cover, 1 cap, and 10 nut covers per kit

**10243** 1 Kit / Color Box

### Light Bulb



### High Power 1156 LED Bulb

- Single function LED bulb with maximum 275 lumens
- 360° surround illumination, 180° front illumination
- Long life sealed design

**36465** Amber - 1 Pc. / Card

**36466** Red - 1 Pc. / Card

**36467** White - 1 Pc. / Card

### LED Rear Center Panel



### COMPETITION SERIES

### Stainless Rear Center Panel - Competition Series

- Polished 430 stainless steel center panel w/ enclosed steel back panel, item # 21475
- Four 7 red LED w/ red lens S/T/T light, item #39117B
- Includes LED license light, chrome license frame, bullet fastener, and rubber grommet

**35082** 1 Pc. / Color Box



### 2" Hitch Cover

- Fits Standard 2" x 2" Tow Hitch Receivers
- Mounts in Place with Standard Hitch Pin & Clip (Sold Separately 77051)
- Keeps Dirt and Debris out of hitch receiver and gives a Super Clean Look
- Corrosion resistant, made of high quality plastic polymer

**77007** Chrome - 1 Pc. / Card

**77008** Black - 1 Pc. / Card



## LED Light Bar



### Chrome 10 LED Light Bar with 180° Swivel Base

- Available with dual function LED light bar
- Base swivels 180° for multiple application

|              |   |
|--------------|---|
| <b>33009</b> | Dual Function Red LED/Red Lens - 1 Pc. / Card     |
| <b>33013</b> | Dual Function Red LED/Clear Lens - 1 Pc. / Card   |
| <b>33015</b> | Dual Function Amber LED/Amber Lens - 1 Pc. / Card |
| <b>33016</b> | Dual Function Amber LED/Clear Lens - 1 Pc. / Card |
| <b>33017</b> | Dual Function White LED/Clear Lens - 1 Pc. / Card |

## Package Upgrades / Merchandising



**NEW COLOR PACKAGING** **DOT & SAE APPROVED**

### Technical Specification

**Low Beam Application**  
12V DC Input  
9007 Light Bulb  
4.3 Amps / 55 Watt

**High Beam Application**  
12V DC Input  
9007 Light Bulb  
5.1 Amps / 65 Watt

### Headlight for 2008+ Peterbilt 382/384/386/387

- Headlight assembly for Peterbilt 382 2007-2018 / Peterbilt 384 2007-2014 Peterbilt 386 2005-2015 / Peterbilt 387 1999-2010
- Easy connection, plug & play design, plugs into existing headlight wiring harness
- Amber turn signal light bulb (1157) included
- Headlight bulbs included, Dot/Sae headlight approved
- Sold individually, please specify driver or passenger side
- OEM number: 16-09190-L / 16-09190-R

**31295** Driver - 1 Pc. / Color Box

**31296** Passenger - 1 Pc. / Color Box

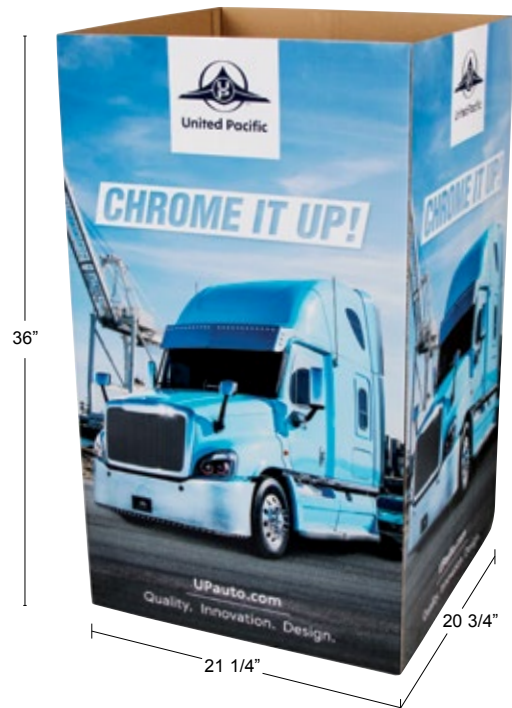

### United Pacific Square Bin Box

- United Pacific Bin Box, 24 1/4" x 20 3/4" x 36"

**99123** 1 Pc. / Bulk

# NEW ITEMS

November 2018

Headlight Assembly for Kenworth T680 & T660, Grille Accessories for Cascadia & Peterbilt 379, and Many More

## Kenworth T680 Headlight



## Projection Headlight with LED Position Light for 2013+ Kenworth T680

- Headlight assembly for Kenworth T680 trucks
- Projection headlight with white LED position light
- Patent pending headlight lens design for improved look and visibility
- Easy connection, plugs into existing wiring harness
- DOT/SAE headlight approved
- Sold Individually, please specify driver or passenger Side
- Patent number, US D830,599
- **1 year warranty**



### Technical Specification

**Low Beam Application**  
 H7 Quartz Halogen Bulb  
 55 Watt / 4.58 Amps  
 12V DC Input

**High Beam Application**  
 H1 Quartz Halogen Bulb  
 55 Watt / 4.58 Amps  
 12V DC Input

|              |          |                                      |
|--------------|----------|--------------------------------------|
| <b>31454</b> | Chrome   | <b>Driver</b> - 1 Pc. / Color Box    |
| <b>31455</b> | Chrome   | <b>Passenger</b> - 1 Pc. / Color Box |
| <b>31456</b> | Blackout | <b>Driver</b> - 1 Pc. / Color Box    |
| <b>31457</b> | Blackout | <b>Passenger</b> - 1 Pc. / Color Box |

## Freightliner Cascadia



### Bumper Air Flow Deflector for 2018+ Freightliner Cascadia

- Sold individually, please specify center, driver or passenger side
- Replace OEM number: 21-28988-000 (driver)/21-28988-001 (passenger)/21-28991-000 (center)

**42472** Driver - 1 Pc. / Box

**42473** Passenger - 1 Pc. / Box

**42474** Center - 1 Pc. / Box

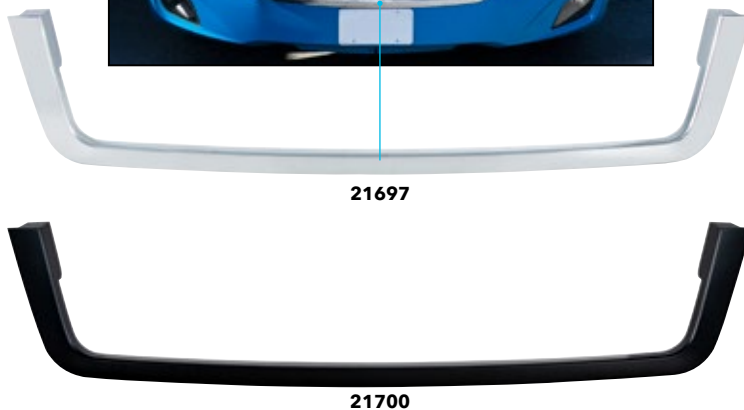

### Bumper Trim for 2018+ Freightliner Cascadia

- Available in chrome or black finish
- Replace OEM number: 21-28982-001/ 21-28982-002

**21697** Chrome - 1 Pc. / Box

**21700** Black - 1 Pc. / Box

### For Peterbilt

**Upgraded & Improved**

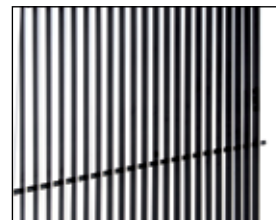
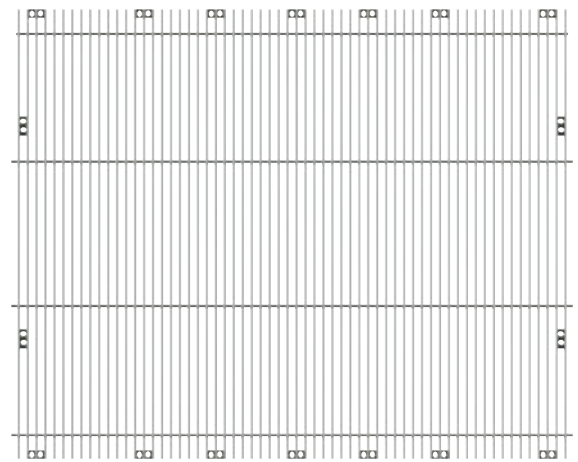

### Billet Style Aluminum Extended Hood Grille for Peterbilt 379

- Clear coated front grille with black powder coated side walls
- Includes all mounting brackets and screw

**21185** 1 Set / Box

**For Kenworth**



**32780**

**Projection Headlight with LED Turn Signal & LED Position Light for 2008+ Kenworth T660**

- Kenworth T660 projection headlight with LED turn signal and LED position light
- Fits 2008+ Kenworth T660 model
- DOT/SAE and FMVSS571 compliant
- Sold individually, please specify driver or passenger side
- **1 year warranty**



**32781**



Unique lens design for added definition of the LED's & side marker

**New Patent Pending Lens Design**

**DOT & SAE APPROVED**



**Technical Specification**

**Low Beam Application**  
12V DC Input  
4.1 Amps / 49.2 Watt  
FMVSS 571

**High Beam Application**  
12V DC Input  
5.1 Amps / 61.2 Watt  
FMVSS 571

|              |          |                                      |
|--------------|----------|--------------------------------------|
| <b>32779</b> | Chrome   | <b>Driver</b> - 1 Pc. / Color Box    |
| <b>32780</b> | Chrome   | <b>Passenger</b> - 1 Pc. / Color Box |
| <b>32781</b> | Blackout | <b>Driver</b> - 1 Pc. / Color Box    |
| <b>32782</b> | Blackout | <b>Passenger</b> - 1 Pc. / Color Box |

**For Peterbilt**

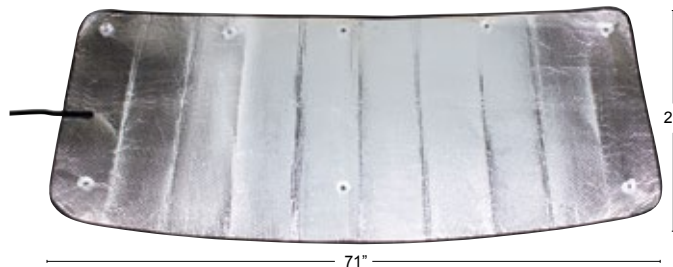

**Windshield Sunshade for 579**

- Fits 2008-2019 Peterbilt 579 trucks
- Blocks damaging UV rays & keeps interior cool
- PE bubble with reflective aluminum coating
- Accordion fold and closure strap for quick & easy storage

**98995** 1 Pc. / Card

**For Freightliner**

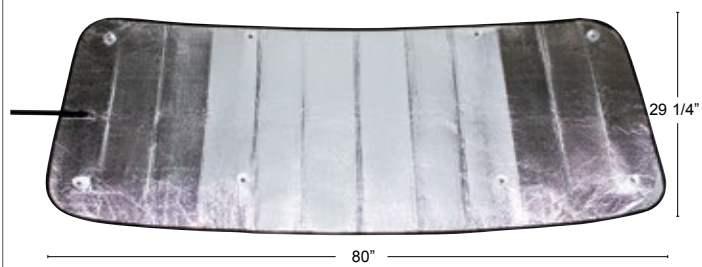

**Windshield Sunshade for Cascadia**

- Fits 2008-2018 Freightliner Cascadia trucks
- Blocks damaging UV rays & keeps interior cool
- PE bubble with reflective aluminum coating
- Accordion fold and closure strap for quick & easy storage

**98997** 1 Pc. / Card

## Universal Product



### 5" x 51" Exhaust Muffler

- OE style muffler for many commercial truck models
- Heavy gauge steel with aluminized plating
- Rated flow: 2400 CFM
- Inner diameter: 5"
- Outlet diameter: 5"
- Muffler body diameter: 10"
- Muffler body length: 44 1/2"
- Muffler overall length including inlet and outlet: 51"
- Interchange No: M100465, 86682M, 86130M

**10333** 1 Pc. / Box

## Merchandising



### 12 Blanket Bin Box Display - 50" x 60" Flannel Fleece Comfort Blanket

- Includes 3 each of the following
- 99113 - Navy blue blanket
- 99114 - Red blanket
- 99115 - Ash black blanket
- 99116 - Green blanket

**99133** 1 Set / Bulk



### Chrome Combination Winch Bar & Chain Binder 40" Long Knurled Tool

- Chrome plated combination winch and chain binder tool
- Made of high strength steel
- Machined knurl for optimal grip

**90053** 1 Pc. / Bulk



### 9 High Power LED Work Light Bin Box Display

- Includes 4 each of the following
- 36617 - 9 high power LED round work light
- 36618 - 9 high power LED square work light

**99134** 1 Set / Bulk

# NEW ITEMS

December 2018

Headlight Assembly for Peterbilt 388/389, 579/587, Kenworth T680, and more...

## Peterbilt 389 Headlight



### Projection Headlight with LED Position Light & LED Turn Signal for 2008+ Peterbilt 388/389

- Headlight assembly for Peterbilt 388/389 trucks
- Bold and unique headlight design, patent pending design
- Amber LED turn signal with projector lens, white LED position bar, and amber LED side marker
- Easy connection, plug & play design, plugs into existing headlight wiring harness
- DOT/SAE headlight approved
- Sold individually, please specify driver or passenger side
- **1 year warranty**



### Technical Specification

| Low Beam Application | High Beam Application |
|----------------------|-----------------------|
| H11 Halogen Bulb     | HB3 Halogen Bulb      |
| 55 Watt / 4.5 Amps   | 60 Watt / 5 Amps      |
| 12V DC Input         | 12V DC Input          |

|              |          |                                      |
|--------------|----------|--------------------------------------|
| <b>35802</b> | Chrome   | <b>Driver</b> - 1 Pc. / Color Box    |
| <b>35803</b> | Chrome   | <b>Passenger</b> - 1 Pc. / Color Box |
| <b>35804</b> | Blackout | <b>Driver</b> - 1 Pc. / Color Box    |
| <b>35805</b> | Blackout | <b>Passenger</b> - 1 Pc. / Color Box |





### Projection Headlight with LED Position Light & LED Turn Signal for 2008+ Peterbilt 388/389

- Headlight assembly for Peterbilt 388/389 trucks
- Projection headlight with LED position light and LED turn signal
- Patent pending headlight lens design for improved look and visibility
- Easy connection, plugs into existing wiring harness
- DOT/SAE headlight approved
- Sold Individually, Please Specify Driver or Passenger Side
- **1 Year Warranty**

|              |          |                                      |
|--------------|----------|--------------------------------------|
| <b>31645</b> | Chrome   | <b>Driver</b> - 1 Pc. / Color Box    |
| <b>31646</b> | Chrome   | <b>Passenger</b> - 1 Pc. / Color Box |
| <b>31647</b> | Blackout | <b>Driver</b> - 1 Pc. / Color Box    |
| <b>31648</b> | Blackout | <b>Passenger</b> - 1 Pc. / Color Box |

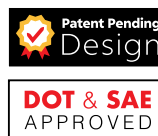

### Technical Specification

|  |   |
|--|---|
| <b>Low Beam Application</b><br>H9 Quartz Halogen Bulb<br>65 Watt / 5.25 Amps<br>12V DC Input | <b>High Beam Application</b><br>H1 Quartz Halogen Bulb<br>55 Watt / 4.58 Amps<br>12V DC Input |
|--|---|

### Peterbilt 579 Headlight

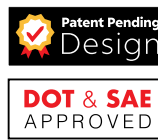
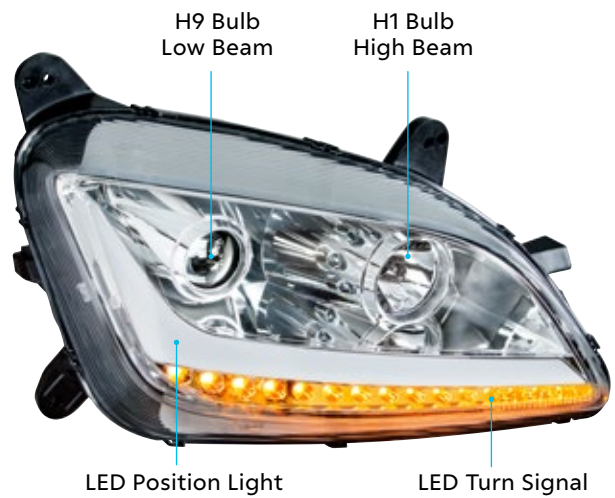

### Projection Headlight with LED Position Light & LED Turn Signal for 2001+ Peterbilt 579/587

- Headlight assembly for Peterbilt 579 & 587 trucks
- Projection headlight with LED position light and LED turn signal
- Patent pending headlight lens design and reflective turn signal diffusers for wider visibility
- Easy connection, plugs into existing wiring harness
- DOT/SAE headlight approved
- Sold individually, please specify driver or passenger side
- **1 year warranty**

### Technical Specification

|  |   |
|--|---|
| <b>Low Beam Application</b><br>H9 Quartz Halogen Bulb<br>65 Watt / 5.25 Amps<br>12V DC Input | <b>High Beam Application</b><br>H1 Quartz Halogen Bulb<br>55 Watt / 4.58 Amps<br>12V DC Input |
|--|---|

|              |          |                                      |
|--------------|----------|--------------------------------------|
| <b>35812</b> | Chrome   | <b>Driver</b> - 1 Pc. / Color Box    |
| <b>35813</b> | Chrome   | <b>Passenger</b> - 1 Pc. / Color Box |
| <b>35814</b> | Blackout | <b>Driver</b> - 1 Pc. / Color Box    |
| <b>35815</b> | Blackout | <b>Passenger</b> - 1 Pc. / Color Box |

## Kenworth T680 Headlight



**HID**  
High Intensity Discharge



**DOT & SAE**  
APPROVED

### Projection HID Headlight Assembly for 2013+ Kenworth T680

- Headlight assembly for Kenworth T680 trucks
- Easy connection, plugs into existing wiring harness
- DOT/SAE headlight approved
- Sold individually, please specify driver or passenger side
- **1 year warranty**

#### Technical Specification

| Low Beam Application | High Beam Application |
|----------------------|-----------------------|
| D1S Bulb             | HB3A Bulb             |
| 3200 Lumen / 35 Watt | 1700 Lumen / 65 Watt  |
| FMVSS 108            | FMVSS 108             |

|              |          |                                |
|--------------|----------|--------------------------------|
| <b>35816</b> | Blackout | 1 Pair / Box                   |
| <b>35817</b> | Chrome   | <b>Driver</b> - 1 Pc. / Box    |
| <b>35818</b> | Chrome   | <b>Passenger</b> - 1 Pc. / Box |

## LED Headlight



#### Technical Specification

| Low Beam Application | High Beam Application |
|----------------------|-----------------------|
| 900 Lumens           | 1,300 Lumens          |
| 25 Watt / 5700K      | 25 Watt / 5700K       |

### High Power LED 7" Headlight with LED Turn Signal/ Position Light Bar

- High power LED headlight with LED turn signal/position light bar for powerful performance
- Aluminum housing with proprietary heat management provides maximum protection for long-lasting performance
- Solid state design resists shock and vibration
- Easy connection, fits OEM housing or fender, plugs into existing wiring harness, position light requires additional wiring
- DOT/SAE headlight approved

|              |  |
|--------------|--|
| <b>31458</b> | <b>Amber LED / Dual Function Light Bar</b> - 1 Pc. / Color Box   |
| <b>31459</b> | <b>White LED / Single Function Light Bar</b> - 1 Pc. / Color Box |



#### Technical Specification

| Low Beam Application |                      |          |
|----------------------|----------------------|----------|
| 12 - 24V DC Input    | 0.35 Amps / 8.5 Watt | FMVSS108 |

### High Power LED 4" x 6" Rectangular Headlight with 6 LED Position Lights - Low Beam

- High power LED low beam headlight with 6 LED position light
- Available in single function white LED and dual function amber LED
- Die cast aluminum housing provides maximum protection from the elements
- Solid state design resists shock and vibration
- Improve visibility with light output that is closer to the color temperature of daylight

|              |  |
|--------------|--|
| <b>31168</b> | <b>White LED/Single Function</b> - 1 Pc. / Color Box |
| <b>31237</b> | <b>Amber LED/Dual Function</b> - 1 Pc. / Color Box   |



For Freightliner

**BUG SCREEN INCLUDED**



42475



42476



### Grille with Bug Screen for 2018+ Freightliner Cascadia

- Fits 2018+ Freightliner Cascadia
- Bug screen included
- Mounting hardware included
- Approximate dimension: 48 1/2" L x 29" W
- Available in chrome or black finish
- OEM number: A17-20832-013 (Chrome)/A17-20832-008 (Black)

**42475** Chrome - 1 Pc. / Box

**42476** Black - 1 Pc. / Box



42461

42462



42465

42466

### Bumper Cover without Deflector Holes for 2018+ Freightliner Cascadia

- Corner bumper cover for 2018+ Freightliner Cascadia
- Available with and without fog lamp hole
- Replace OEM number: 21-28980-000 (Item # 42460)/21-28980-001 (Item # 42461)/21-28980-004 (Item # 42462)/21-28980-005 (Item # 42463)
- Sold individually, please specify driver or passenger side

|              |                       |                                |
|--------------|-----------------------|--------------------------------|
| <b>42460</b> | without Fog Lamp Hole | <b>Driver</b> - 1 Pc. / Box    |
| <b>42461</b> | without Fog Lamp Hole | <b>Passenger</b> - 1 Pc. / Box |
| <b>42462</b> | with Fog Lamp Hole    | <b>Driver</b> - 1 Pc. / Box    |
| <b>42463</b> | with Fog Lamp Hole    | <b>Passenger</b> - 1 Pc. / Box |

### Bumper Cover with Deflector Holes for 2018+ Freightliner Cascadia

- Corner bumper cover for 2018+ Freightliner Cascadia
- Available with and without fog lamp hole
- Replace OEM number: 21-28980-008 (Item # 42464)/21-28980-009 (Item # 42465)/21-28980-012 (Item # 42466)/21-28980-013 (Item # 42467)
- Sold individually, please specify driver or passenger side

|              |                       |                                |
|--------------|-----------------------|--------------------------------|
| <b>42464</b> | without Fog Lamp Hole | <b>Driver</b> - 1 Pc. / Box    |
| <b>42465</b> | without Fog Lamp Hole | <b>Passenger</b> - 1 Pc. / Box |
| <b>42466</b> | with Fog Lamp Hole    | <b>Driver</b> - 1 Pc. / Box    |
| <b>42467</b> | with Fog Lamp Hole    | <b>Passenger</b> - 1 Pc. / Box |



42469



42470

### Bumper Reinforcement for 2018+ Freightliner Cascadia

- Bumper reinforcement for 2018+ Freightliner Cascadia
- Available with and without fog lamp hole
- Replace OEM number: 21-28981-000 (Item # 42468)/21-28981-001 (Item # 42469)/21-28981-002 (Item # 42470)/21-28981-003 (Item # 42471)
- Sold individually, please specify driver or passenger side

|              |                       |                                |
|--------------|-----------------------|--------------------------------|
| <b>42468</b> | without Fog Lamp Hole | <b>Driver</b> - 1 Pc. / Box    |
| <b>42469</b> | without Fog Lamp Hole | <b>Passenger</b> - 1 Pc. / Box |
| <b>42470</b> | with Fog Lamp Hole    | <b>Driver</b> - 1 Pc. / Box    |
| <b>42471</b> | with Fog Lamp Hole    | <b>Passenger</b> - 1 Pc. / Box |

**Universal Products**



**3 hole bolt patterns fits existing steering wheel hubs. No need for special 3-5 hub adapter**

**Chrome Billet Style 18" Steering Wheel**

- Chrome aluminum steering wheel rim
- High quality CNC aluminum with chrome plating
- Steering wheel only. Hub and horn button assembly available separately
- Mix and match with United Pacific hubs and designer horn bezels for a unique and distinctive look

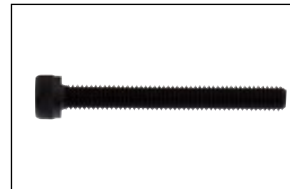

Includes special extended screws for installation



**88171** 1 Pc. / Color Box



**88263**



**88264**



**18" Glacier White Steering Wheel**

- High Quality steel with chrome plating
- Steering wheel only. Hub and horn button assembly available separately
- Solid state design resists shock and vibration
- Mix and match with United Pacific hubs and designer horn bezels for a unique and distinctive look

**88263** 4 Spoke - 1 Pc. / Color Box

**88264** Boss - 1 Pc. / Color Box

**For Kenworth**



**Chrome Steering Wheel Hub & Horn Button Kit for 1997- 2001 Kenworth Trucks**

- Quality chrome plated diecast
- Fits any 3-Bolt United Pacific Steering Wheels
- Wheel hub with 36 spline center steering shaft mounting hole

**88262** 1 Pc. / Box

**NEW & IMPROVED**



### Chrome 7/16" Top Gearshift Mounting Adapter for Eaton-Fuller 13/15/18 Speed Shifters

- Chrome diecast gearshift mounting adapter for United Pacific CNC gear shift knobs
- New self-centering o-ring design, o-ring provided for a tight fit and reduces vibration
- Fits all Eaton-Fuller 13/15/18 speed shifters

**70603B** 1 Pc. / Bulk

#### For Volvo VN



### Headlight Assembly with Turn Signal for 1996 - 2003 Volvo VN

- Direct OEM replacement
- Crystal clear lens, perfect for replacing old faded headlight set
- Replacement 9007/HB5 bulbs available separately, item number: 39127/39128
- Replacement turn signal 1157 bulbs available separately: item number 39012B
- Replace OEM number: 8082041/8082040 (headlight), 20571061/ 20571062 (turn signal)
- 4 pcs. set includes 2 headlights (driver/passenger) and 2 turn signals (driver/passenger)

**35783** 1 Set / Box



### Chrome Passenger A/C Vent Trim for Kenworth T680

- Beautiful chrome plating with triple chrome plating process
- Identical mounting design as original for easy replacement
- OEM number: S18-1034-4100

**41805** 1 Pc. / Card

#### Universal Products



### Heavy Duty Steel King Pin Lock with 12" Warning Tag

- Heavy duty steel fifth wheel lock for standard fixed king pin
- Trailer theft deterrent device
- Feature strong slide bolt lock with 2 keys
- Covers the entire king pin and prohibits its engagement with the fifth wheel
- Steel with zinc plated housing
- 12" chain with high visibility yellow warning tag included
- Keyed different

**90107** 1 Pc. / Color Box



**34103**

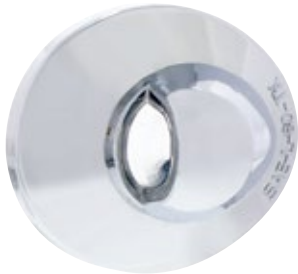

**34102**



### License Plate Light Lens for 1990-2004 Ford Truck

- OEM style with mounting tabs for easy installation
- High quality plastic housing in chrome plated with triple chrome plating process or painted black finish
- OEM number: F67Z-13550-AA/ F67Z-13550-A

**34102** Chrome - 1 Pc. / Card

**34103** Black - 1 Pc. / Card

### Merchandising



### United Pacific Analog Neon Wall Clock

- Nostalgic blue neon light design
- Chrome plate outer bezel
- Clock face features beautiful shot of the UPI's 1932 5-Window Coupe built by Roy Brizio, and customized UPI sponsored Cascadia

**99049** 1 Pc. / Color Box

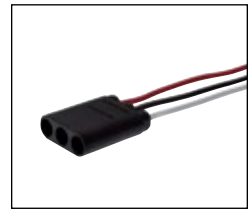

### Triple Bullet Plug Wire Harness

- Made specially for custom set up with 3-function lights
- Water proof over-molded plug housing
- Available with 6" lead/150 plugs/74" length and 12" lead/100 plugs/99" length

**34191** 6" Lead/150 Plugs/74' Length - 1 Roll / Bulk

**34192** 12" Lead/100 Plugs/99' Length - 1 Roll / Bulk



### United Pacific Metal Cooler Box

- Retro style 1940's-1950's metal picnic cooler
- Beautiful blue painted steel exterior with chrome plated carrying handle and corner protectors
- Aluminum lined interior keeps contents cool and fresh
- Convenient built-in bottle opener on side
- Great counter display for retail stores, man cave, RV, etc.

**99118** 1 Pc. / Box



# TERMS & CONDITIONS / ORDERING GUIDELINES / FREIGHT

IMPORTANT: PLEASE REVIEW CAREFULLY

## New Accounts:

Initial minimum buy-in is \$2,000 (or to be determined by United Pacific Industries, UPI hereafter). All initial orders must be prepaid in advance by Cashier's Check or VISA/MC. All new/potential accounts must complete a UPI "New Customer Info/Credit Form" and follow the Dealer Qualification Instructions. Upon completion of the credit application, approved accounts will be assigned payment terms of NET 30 Days (from invoice date). Accounts denied a credit line will be required to prepay in advance by Cashier's Check or VISA/MC.

## PAYMENT TERMS

### Term Accounts:

Accounts with NET 30 Days terms are required to submit payment within the 30 days from the date of invoice. Acceptable forms of payment include checks, ACH (Automated Clearing House), or wire transfer.

A service charge of 1.5% per month will be imposed on invoices not paid within the 30 day term. Delinquent accounts will be required to pay Cash-In- Advance (CIA). Checks will be accepted but orders will not be released until the check is cleared by the bank. Past due invoices will delay current orders. Please check with UPI on your account status when placing an order.

### Credit Cards

Accounts denied credit terms may pay by Visa or MasterCard. Credit card will be charged upon shipment. Credit card payments will not be accepted once an order has been shipped. UPI does not accept American Express or Discover card.

### COD

A \$9.00 fee will be assessed per COD box for all FedEx/UPS COD shipments. Truck COD shipment fees are to be determined later by trucking company.

### Returned Checks:

A \$30 NSF (Non Sufficient Fund) fee will be assessed on each incidence a check is returned to UPI.

## ORDERING GUIDELINES

Placing Orders: New orders may be placed by any of the following methods

1. Fax: **888.986.5988**
2. E-mail: [antique@upauto.com](mailto:antique@upauto.com)
3. Telephone: In order to minimize errors, customers are encouraged to submit their orders by fax or email. Telephone orders should be limited to smaller orders such as add-ons to orders already submitted and/or fill-ins occurring between larger restocking orders.

### Changes to Orders:

Whenever possible, revisions to orders - additions or deletions of items - should also be submitted via fax or email to reduce the possibility of errors.

Additions/Deletion of items will only be accepted within 48 hours after the initial order date and/or before 12:00PM on the date of the shipment. Additions of items placed after the 48 hours time period will be considered a new order and adhere to a new order freight prepaid policy. Deletions of item cannot happen after the 48 hours time period and/or after 12:00PM on the date of the shipment. Please note additions and/or deletions of items will delay the shipment date.

### Canceling Orders:

Cancellation of orders must be submitted via fax or email within 24 hours of the order date. If the order has already shipped it will be the customers responsibility to return the order at the customers own expense. A restocking fee may apply, please see "Return" policy for further detail.

## Backorders:

Customers have the option of having their backorders shipped or canceled. UPI will notify customer as to availability of backorders and will be able to ship any backorder items customer still needs as part of their next stock order. UPI reserves the right to cancel backorders that are 6 months or older from the initial invoice date.

## Minimum Order:

A minimum order of \$50.00 is required. Orders below \$50.00 will be assessed a minimum order fee of \$10.00.

## Packaging:

A 10% service charge will be added to orders with special packaging or UPC barcoding requirements.

## Lead Times:

Standard lead time for all United Pacific orders is 1-3 business days from the receipt of the purchase order. Larger orders may require a lead time of up to 5 business days. Transit time of 3-5 business days must be considered when placing orders. UPI cannot be responsible for delays in shipment after an order leaves our warehouse. UPI will work to resolve delays with freight forwarding firms, however, delays do arise from time to time due to weather and unforeseen circumstances beyond UPI's control. Express order are exempted; please view Freight/Shipping Policy for further detail.

## Order Confirmation:

United Pacific will acknowledge receipt of orders by email/fax/ telephone within 1 business day of receipt. If confirmation is not received, please contact UPI to ensure your order was received.

## FREIGHT

### Prepaid Freight:

Stock orders between \$50 and \$999.99 (US Lower 48 States), **\$50 and \$2499.99 (Alaska and Hawaii)**, **\$50 and \$1499.99 (Canada)**, [all price net US\$], will be shipped FOB Long Beach, California. Stock orders of \$1,000 (US Lower 48 States), **\$2500 (Alaska and Hawaii)**, **\$1500 (Canada)**, [based on UPI current pricing], or more will be shipped Freight Prepaid Ground to a single location only. (See exception for Oversize Items\*). Express Air orders, Special Net Pricing orders, and Special Quote Pricing orders are excluded. United Pacific reserves the right to select the carrier of our choice. Customers may select the carrier of their choice at their own expense, negotiated rates and insurance. If customers elect to choose their own freight carrier, orders will be shipped via FREIGHT COLLECT. **Oversize Item Freight Policy** – Applies to 1932 Ford car & truck body shell assemblies, 1932 Ford car & truck body parts such as floor assembly, roof, door, fender, quarter panel, grille, bulk rail gutter, bulk roof tack strip, chassis & frame, wheels & tire, and any exceptionally large or heavy item.

1. Freight will be prepaid by United Pacific if the total order of all items exceeds \$4,000 (US Lower 48 States) or **\$5000 (Hawaii, Alaska and Canada)**, [all price net US\$]. There will not be additional charges for these items included on the order.
2. Freight will be prepaid by United Pacific if a customer orders a total of \$2,500 (US Lower 48 States) or **\$3500 (Hawaii, Alaska and Canada)**, [all price net US\$], of PB 379 fenders, 60" or longer exhaust, and/or 18"+ Longer Saddle Boxes only. If the order is below \$2,500 (US Lower 48 States) or **\$3500 (Hawaii, Alaska and Canada)**, United Pacific will add freight charges to the order for the oversize items.

### Will Call Orders:

Will Call orders can be picked up 2 - 4 hours after placing the order. Customers should always call ahead to confirm when order will be ready to pick up.

# SHIPPING POLICY / CLAIMS

IMPORTANT: PLEASE REVIEW CAREFULLY

## SHIPPING POLICY

### International Shipments:

Shipments to locations outside the continental United States will be shipped to the customer's shipping agent or broker within the continental United States in accordance with the US freight policy. International customers will be responsible for the duties and taxes of their respective country.

### Express Orders:

All express orders, such as Next Day, Second Day, 3 Day Service & Will Call, must be faxed/emailed. Order confirmation will be faxed to the customer for final approval. If confirmation is not received, please contact UPI to ensure your order was received. Customers are required to sign off on express orders and fax confirmation back to UPI. Cut off for express order is 12:00PM. Express orders received after 12:00PM may or may not ship the same day. Please call UPI to confirm projected shipping date or will call time.

Due to the high cost of express shipments, customer may request UPI to call to confirm freight charges. If customer does not request confirmation, UPI will ship the express order.

### Drop Shipments:

All drop shipment orders will be assessed a 5% processing fee. Drop shipment processing fee will be automatically added to the invoice without notice. All drop shipment orders must be faxed in. No freight allowance or prepaid freight will be permitted for any drop shipments, thus, all drop ship orders, regardless of order size, are FOB Long Beach, CA.

## CLAIMS

### General Policy:

All claims (Shortage, Mis-Shipped, Damage, Overage, Customer Error & Billing Error) must be submitted to UPI within 3 business days of the receipt of shipment. Claims submitted beyond 3 business days of the receipt of shipment will be voided by UPI.

On all shipments, the person who signs and receives the shipment is responsible for noting on the Bill of Lading, in writing, whether any boxes arrived damaged or shorted. Failure to do so will void all claim rights between all parties. UPI will have no recourse against the trucking company if customer does not note any damages or shortages on the Bill of Lading.

The customers receiving department must count and sign for the exact number of boxes received. Failure to follow the above instructions will void all claim rights between all parties.

### Shortages / Mis-Ships / Damages:

While UPI strives to fill every order with 100% accuracy, on occasion an item may get shipped in error or get damaged during shipping. In the event this occurs, please follow the process below. Note: This type of claim must be reported to UPI within three (3) business days of receiving the order.

1. Contact the United Pacific office to initiate the claim. To make it easy for you we have two acceptable methods for requesting the claim:
  - By e-mail : [returns@upauto.com](mailto:returns@upauto.com)
  - By fax : **888.986.5988**
  - \* **Note: To ensure you receive a timely credit, we cannot accept claim requests by phone.**
2. You will be required to provide the following information:
  - Your business name
  - Contact name and telephone number (in case we have questions)
  - Date the order was received

- A copy of the Packing List / Invoice noting the item number and quantity that was shipped in error or damaged during shipping.
  - Special instructions you have for us.
3. UPI will send a return label so you can ship the items back.
  4. Once we receive the miss-shipped/damaged item(s) a credit will be issued to your account on the next billing cycle.
  5. Shortages will be credit to the Customers' account, unless customer would like the shortages replaced.

### Overages:

UPI strives to provide our customers with the best customer service and products, in turn we would greatly appreciate any help from customer in notifying UPI of any shipping overages. Customers will be offered the option of retaining the merchandise or returning the merchandise to UPI at UPI's expense. If the items are to be returned, an RMA number and return shipping label will be provided.

### Customer Errors:

Any item or quantity ordered in error by the customer may be returned by contacting UPI for a RMA No.

1. To make it easy for you we have two acceptable methods for requesting the RMA:
  - By e-mail: [returns@upauto.com](mailto:returns@upauto.com)
  - By fax: **888.986.5988**
  - \* **Note: To ensure you receive a timely RMA credit, we cannot accept RMA requests by phone.**
2. You will be required to provide the following information.
  - \* Your business name
  - \* Contact name and telephone number (in case we have questions)
  - \* A list of the items number and quantity ordered in error
  - \* Special instructions you have for us
3. UPI will review the request to ensure the products are within the return period.
4. Once we have validated the request, United Pacific will issue an RMA number to the customer. In issuing the RMA approval, the following conditions will apply :
  - Returned items are subject to a 20% re-stocking fee.
  - Return shipping costs are the responsibility of the customer.
  - Items must not have any retail/price sticker on exterior packaging or they will be returned to the customer at customer's expense and no credit given.
  - Items must be in good condition with original packaging intact or they will be returned to the customer at customer's expense and no credit given.
  - Allow up to 30 days for the credit to be issued from the time the returned items are received.

### Billing Errors:

Billing errors should be reported to UPI within 3 business days of invoice receipt. Customers are asked to provide the invoice number, part number, and quantities in question. Once verified, UPI will issue a credit or an invoice for the difference in billing error.

# WARRANTY POLICY / RETURNS

IMPORTANT: PLEASE REVIEW CAREFULLY

## WARRANTY POLICY

### General Policy:

UPI offers a NO HASSLE WARRANTY RETURN policy to all our customers. Warranty claims can only be submitted through an authorized UPI Distributor. UPI warranty is not transferable and applies to the original installation and purchase only. In no event shall UPI be liable for incidental or consequential damages, nor shall UPI be liable for any claims or damages arising out of or connected with the UPI warranty exceed the purchase price of the products. There are no warranties, expressed or implied (including any warranty of merchantability or fitness) that extend beyond this warranty. The warranty does not apply to costs associated with the loss of use of the product, loss of time, inconvenience, commercial loss, incidental or consequential damages. UPI reserves the right to alter the designs of products without assuming any obligation to modify previously manufactured products and will only replace warranted products with redesigned products.

Warranty does not apply to merchandise that has been drilled, cut, welded, modified in any way or installed contrary to normal installation and usage. In addition, UPI cannot be held liable for damages caused by road hazards, accidents, misuse, neglect, abuse or corrosive environments including acid washes and highway snow/ice chemicals which can cause discoloration and corrosion in aluminum, chrome, stainless steel and light products. UPI reserves the right to credit returned merchandise at the initial purchase price or at the current selling price, which price ever is lower.

### Aluminum / Chrome / Stainless Steel Products:

All aluminum, chrome, and stainless steel products carry a limited 6 month warranty (from invoice date) against defects in material or workmanship.

### Lighting Products:

#### Incandescent

All incandescent lighting products carry a limited 12 month warranty (from invoice date) against defects in material or workmanship. The limited 12 month warranty does not apply to several applications, such as, buses, construction equipment, and off road vehicles.

#### LED

All LED lighting products carry a specific Limited Warranty (from invoice date) against defects in material or workmanship.

- LED with vehicle specific application is limited lifetime warranty to an original purchaser with receipt. Examples of lifetime warranty product: CTL5720LED CTL5720LED for 1957 Chevy, FTL3201LED-L for 1932 Ford.
- LED Marker, 2", 2-1/2", 4", 7", Oval & Square Lights - Varies from 2 years to 10 years to Limited Lifetime, depending on specific item. The housing, bezel or mounting base on any light made from Chrome/Stainless carries a 6 month limited warranty.
- LED Cab Lights and Kits, Double/Single Stud Turn Signal and PB/KW/FL/VL or non-make Turn Signals and any/all Strip Lights - Varies from 2 years to 10 years to Limited Lifetime, depending on specific item. The housing, bezel or mounting base on any light made from Chrome/Stainless carries a 6 month limited warranty.
- LED Beacon, Driving, Headlights, Work & Warning Lights - Varies from 6 months to 3 years. The housing, bezel or mounting base on any light made from Chrome/Stainless carries a 6 month limited warranty.
- All LED Accessory Lights (Honda, Stainless Steel Double/Single face Lights, Interior Lights, License Plate Lights, and any Accent Lights. The housing, bezel or mounting base on any light made from Chrome/Stainless carries a 6 month limited warranty.

## RETURNS

### General Policy:

All returns must be authorized by UPI. All return requests must be faxed or e-mailed ([returns@upauto.com](mailto:returns@upauto.com)) A RMA number (Return Merchandise Authorization Number) will be provided. Returns not possessing a valid RMA number are subject to rejection and will be returned to sender at the customer's expense. All customers are encouraged to use the Warranty RMA Claim Form.

### Defective Goods / Warranty Return:

UPI offers our customers a No Hassle Warranty Return. Please follow the instructions below for requesting a RMA for defective goods:

1. If any warranty issues occur, simply contact the UPI for RMA number  
To make it easy for you we have two acceptable methods for requesting the RMA:
  - By e-mail: [returns@upauto.com](mailto:returns@upauto.com)
  - By fax: [888.986.5988](tel:888.986.5988)
  - **Note: To ensure you receive a timely RMA credit, we cannot accept RMA requests by phone.**
2. You will be required to provide the following information:
  - Your business name
  - Contact name and telephone number (in case we have questions)
  - A list of the defective item number and quantity with the nature/reason of the defect
  - Special instructions you have for us
  - The enclosed fax form may be used for your convenience to request an RMA
3. UPI will review the request to ensure the products are within the stated warranty period.
4. Once we have validated the warranty items, a RMA confirmation, listing the items and cost will be faxed to the customer within 3 business days. UPI will process the credit to your account within 30 days.

**Note: There will be no need to return the warranty product to us. However, from time to time, UPI may require some warranty products to be shipped back so we may analyze the cause of the failure. All warranty products that are required to be shipped back will be freight prepaid by UPI.**

### Stock Return:

United Pacific Industries encourages all customers to regularly monitor the sales volume and stock level of their inventory items. As sales trends may slow the movement of specific items, our hope is that those items are featured as "close-out specials" as to minimize stock returns. We also understand that the customer, from time to time, may accumulate over-stock items and desire to return those. Therefore, we have adopted the following policy below.

#### NOTE:

- Items must have been purchased by the dealer requesting the stock return.
  - Items must have been purchased within the preceding 12 months.
  - Items that have been discontinued will not be considered for return.
1. Contact the United Pacific office for RMA number We have 2 acceptable methods for requesting the RMA:
    - By e-mail : [returns@upauto.com](mailto:returns@upauto.com)
    - By fax : [888.986.5988](tel:888.986.5988)
    - **\*Note: To ensure you receive a timely RMA credit, we cannot accept RMA requests by phone.**





| ITEM # | PAGE # | ITEM # | PAGE # | ITEM # | PAGE # | ITEM # | PAGE # |
|--------|--------|--------|--------|--------|--------|--------|--------|
| 10243  | 55     | 21931  | 22     | 31201  | 36     | 32804  | 36     |
| 10333  | 60     | 21932  | 22     | 31202  | 36     | 32805  | 36     |
| 10389  | 8      | 21933  | 22     | 31234  | 10     | 32806  | 36     |
| 10390  | 8      | 21934  | 22     | 31237  | 63     | 32807  | 36     |
| 10408  | 54     | 21935  | 22     | 31259  | 36     | 32808  | 36     |
| 10657  | 7      | 21936  | 22     | 31267  | 36     | 32809  | 36     |
| 10850  | 41     | 21937  | 22     | 31295  | 56     | 32810  | 36     |
| 10924  | 54     | 21938  | 12     | 31296  | 56     | 33009  | 56     |
| 10934  | 54     | 21940  | 22     | 31312  | 16     | 33013  | 56     |
| 10945  | 54     | 22956  | 31     | 31313  | 16     | 33015  | 56     |
| 10946  | 19, 54 | 22957  | 31     | 31314  | 16     | 33016  | 56     |
| 10963  | 54     | 22958  | 31     | 31315  | 16     | 33017  | 56     |
| 10964  | 54     | 22959  | 31     | 31319  | 6      | 34102  | 67     |
| 10965  | 5      | 22964  | 31     | 31320  | 6      | 34103  | 67     |
| 10966  | 5      | 22965  | 31     | 31344  | 40     | 34191  | 67     |
| 10967  | 5      | 22966  | 31     | 31345  | 40     | 34192  | 67     |
| 11224  | 23     | 22967  | 31     | 31346  | 47     | 34235  | 27, 26 |
| 11302  | 45     | 22968  | 31     | 31386  | 36     | 34280  | 10     |
| 11322  | 30     | 22969  | 31     | 31454  | 57     | 34281  | 10     |
| 20480  | 33     | 22970  | 31     | 31455  | 57     | 34496  | 20, 34 |
| 21052  | 17     | 22971  | 31     | 31456  | 57     | 34497  | 20, 34 |
| 21076  | 17     | 22972  | 31     | 31457  | 57     | 34498  | 20, 34 |
| 21185  | 58     | 22973  | 31     | 31458  | 63     | 34499  | 20, 34 |
| 21312  | 13     | 22979  | 31     | 31459  | 63     | 34564  | 34     |
| 21397  | 7      | 22980  | 31     | 31645  | 62     | 34565  | 34     |
| 21533  | 19     | 22981  | 31     | 31646  | 62     | 34566  | 34     |
| 21534  | 19     | 22982  | 31     | 31647  | 62     | 34567  | 34     |
| 21688  | 37     | 22983  | 31     | 31648  | 62     | 34664  | 34     |
| 21689  | 37     | 22984  | 31     | 32051  | 35, 36 | 34665  | 34     |
| 21690  | 37     | 22985  | 31     | 32052  | 35, 36 | 34666  | 34     |
| 21695  | 43     | 22986  | 31     | 32053  | 35     | 34667  | 34     |
| 21696  | 37, 43 | 22987  | 31     | 32054  | 35     | 35073  | 34     |
| 21697  | 58     | 22988  | 31     | 32355  | 26     | 35074  | 34     |
| 21700  | 58     | 23364  | 31     | 32356  | 26     | 35081  | 39     |
| 21792  | 12     | 23365  | 31     | 32588  | 26     | 35082  | 55     |
| 21793  | 12     | 23386  | 31     | 32589  | 26     | 35173  | 34     |
| 21794  | 12     | 23387  | 31     | 32779  | 59     | 35174  | 34     |
| 21796  | 12     | 31090  | 49     | 32780  | 59     | 35783  | 66     |
| 21797  | 12     | 31091  | 49     | 32781  | 59     | 35788  | 43     |
| 21798  | 12     | 31092  | 49     | 32782  | 59     | 35789  | 27     |
| 21799  | 12     | 31093  | 49     | 32783  | 28     | 35798  | 15     |
| 21910  | 12     | 31094  | 49     | 32784  | 28     | 35799  | 15     |
| 21911  | 12     | 31095  | 49     | 32785  | 28     | 35802  | 61     |
| 21912  | 12     | 31096  | 49     | 32786  | 28     | 35803  | 61     |
| 21913  | 12     | 31097  | 49     | 32787  | 36     | 35804  | 61     |
| 21915  | 12     | 31098  | 20     | 32788  | 36     | 35805  | 61     |
| 21916  | 12     | 31099  | 20     | 32789  | 36     | 35812  | 62     |
| 21917  | 12     | 31100  | 30     | 32790  | 36     | 35813  | 62     |
| 21918  | 12     | 31102  | 30     | 32791  | 36     | 35814  | 62     |
| 21919  | 12     | 31150  | 30     | 32792  | 36     | 35815  | 62     |
| 21920  | 12     | 31151  | 30     | 32793  | 36     | 35816  | 63     |
| 21921  | 12     | 31152  | 30     | 32794  | 36     | 35817  | 63     |
| 21922  | 12     | 31153  | 30     | 32795  | 36     | 35818  | 63     |
| 21923  | 12     | 31154  | 9, 25  | 32796  | 36     | 36399  | 50     |
| 21924  | 12     | 31155  | 9, 25  | 32797  | 36     | 36400  | 50     |
| 21925  | 12     | 31156  | 9, 25  | 32798  | 36     | 36401  | 50     |
| 21926  | 12     | 31157  | 9, 25  | 32799  | 36     | 36402  | 50     |
| 21927  | 12     | 31167  | 25     | 32800  | 36     | 36465  | 55     |
| 21928  | 12     | 31168  | 63     | 32801  | 36     | 36466  | 55     |
| 21929  | 12     | 31189  | 10     | 32802  | 36     | 36467  | 55     |
| 21930  | 12     | 31200  | 50     | 32803  | 36     | 36469  | 45     |

| ITEM # | PAGE # | ITEM # | PAGE # | ITEM # | PAGE # | ITEM #   | PAGE # |
|--------|--------|--------|--------|--------|--------|----------|--------|
| 36470  | 45     | 42461  | 64     | 67012  | 54     | 98996    | 40     |
| 36471  | 45     | 42462  | 64     | 67013  | 54     | 98997    | 59     |
| 36504  | 33     | 42463  | 64     | 70092  | 41     | 98998    | 14     |
| 36505  | 38     | 42464  | 64     | 70139  | 41     | 98999    | 14     |
| 36506  | 38     | 42465  | 64     | 70176  | 12     | 99036    | 14     |
| 36509  | 29     | 42466  | 64     | 70403  | 33     | 99049    | 67     |
| 36512  | 5      | 42467  | 64     | 70404  | 33     | 99053    | 6      |
| 36513  | 50     | 42468  | 64     | 70577  | 28     | 99101    | 24     |
| 36591  | 18     | 42469  | 64     | 70578  | 28     | 99105    | 47     |
| 36592  | 18     | 42470  | 64     | 70579  | 28     | 99108    | 13     |
| 36593  | 18     | 42471  | 64     | 70580  | 28     | 99109    | 13     |
| 36594  | 18     | 42472  | 58     | 70581  | 28     | 99113    | 42, 60 |
| 36595  | 18     | 42473  | 58     | 70582  | 28     | 99114    | 42, 60 |
| 36596  | 18     | 42474  | 58     | 70583  | 28     | 99115    | 42, 60 |
| 36597  | 18     | 42475  | 64     | 70584  | 32     | 99116    | 42, 60 |
| 36598  | 18     | 42476  | 64     | 70590  | 32     | 99118    | 67     |
| 36599  | 5      | 42790  | 53     | 70591  | 12     | 99119    | 41     |
| 36600  | 21     | 42811  | 17     | 70592  | 12     | 99123    | 56     |
| 36601  | 21     | 42812  | 17     | 70593  | 12     | 99124    | 47     |
| 36602  | 21     | 42821  | 13     | 70594  | 12     | 99125    | 47     |
| 36603  | 21     | 42822  | 13     | 70595  | 12     | 99133    | 60     |
| 36604  | 23     | 42823  | 6, 13  | 70596  | 12     | 99134    | 60     |
| 36605  | 20     | 42824  | 6, 13  | 70597  | 12     | 110253   | 46     |
| 36606  | 20     | 42825  | 26     | 70674  | 28     | 110383   | 48     |
| 36619  | 29     | 42826  | 26     | 70681  | 22     | 110384   | 48     |
| 36620  | 29     | 46155  | 45     | 70699  | 22     | 110585   | 35, 48 |
| 36626  | 10     | 50130  | 42     | 70708  | 22     | 110586   | 35, 48 |
| 36627  | 10     | 52000  | 42     | 70747  | 28     | 110797   | 46     |
| 36821  | 44     | 52001  | 42     | 70750  | 6      | 110798   | 46     |
| 36822  | 44     | 52002  | 42     | 70751  | 6      | 110799   | 48     |
| 37080  | 8      | 52003  | 42     | 70752  | 22     | 110800   | 48     |
| 37082  | 8      | 52004  | 42     | 70753  | 32     | 110801   | 48     |
| 39132  | 45     | 52005  | 42     | 77007  | 19, 55 | 110802   | 48     |
| 40847  | 13, 29 | 52006  | 42     | 77008  | 19, 55 | 10013CB  | 28     |
| 41021  | 28     | 52007  | 42     | 88171  | 65     | 10349B   | 41     |
| 41443  | 44     | 60051  | 42     | 88174  | 53     | 10351B   | 41     |
| 41449  | 39     | 60052  | 42     | 88175  | 53     | 10718B   | 24     |
| 41450  | 40     | 60053  | 42     | 88176  | 53     | 34047B   | 8      |
| 41695  | 17     | 61762  | 38     | 88177  | 53     | 36862B   | 8      |
| 41696  | 17     | 63792  | 8      | 88211  | 52     | 36864B   | 8      |
| 41756  | 39     | 63793  | 8      | 88212  | 52     | 36924B   | 7      |
| 41760  | 44     | 63794  | 8      | 88213  | 52     | 37036B   | 7      |
| 41763  | 11     | 63795  | 8      | 88238  | 52     | 37128B   | 7      |
| 41764  | 11     | 63796  | 7      | 88259  | 52     | 41751B   | 21     |
| 41765  | 11     | 63797  | 7      | 88262  | 65     | 41752B   | 21     |
| 41766  | 11     | 63808  | 8      | 88263  | 65     | 41753B   | 21     |
| 41767  | 11     | 63809  | 8      | 88264  | 65     | 70589B   | 32     |
| 41768  | 11, 39 | 63810  | 8      | 88300  | 52     | 70603B   | 66     |
| 41769  | 11     | 63811  | 8      | 88301  | 52     | 99117L   | 24     |
| 41770  | 39     | 63812  | 8      | 88302  | 52     | 99117M   | 24     |
| 41773  | 11     | 63813  | 8      | 88303  | 52     | 99117XL  | 24     |
| 41774  | 11     | 63814  | 8      | 88304  | 52     | 99117XXL | 24     |
| 41805  | 66     | 63815  | 8      | 88305  | 51, 52 | 99120L   | 35     |
| 42388  | 53     | 63816  | 7      | 88306  | 51, 52 | 99120M   | 35     |
| 42389  | 53     | 63817  | 7      | 90053  | 60     | 99120XL  | 35     |
| 42390  | 44     | 63818  | 7      | 90107  | 66     | 99120XXL | 35     |
| 42391  | 44     | 63819  | 7      | 90612  | 33     | C5036-3  | 35     |
| 42413  | 21     | 67008  | 54     | 90613  | 33     | S2005LED | 36     |
| 42415  | 21     | 67009  | 54     | 90649  | 23     | S2005LED | 36     |
| 42435  | 32     | 67010  | 54     | 98994  | 29     |          |        |
| 42460  | 64     | 67011  | 54     | 98995  | 59     |          |        |



**UF1218**  
2018 NEW ITEM FLYER COLLECTION



710270058570

[UPauto.com](http://UPauto.com) | T 800.790.6988 | F 888.986.5988